



THE MINI COUNTRYMAN.



ADD STORIES.

The people you never hear from are always the ones with the stories to tell. Chances are that they're in a MINI Countryman, living each day like an adventure. It's a versatile five-seater Sports Activity Vehicle that's more comfortable than ever. With powerful engines and some serious off-road capabilities, it tackles even the trickiest terrain with ease. So what are you waiting for? The world won't explore itself.

Details of fuel consumption and CO₂ emissions for all models, as required under EU law, can be found in the Technical Data section beginning on page 48.

For more information on the options available for each model, contact your MINI dealer or visit mini.com



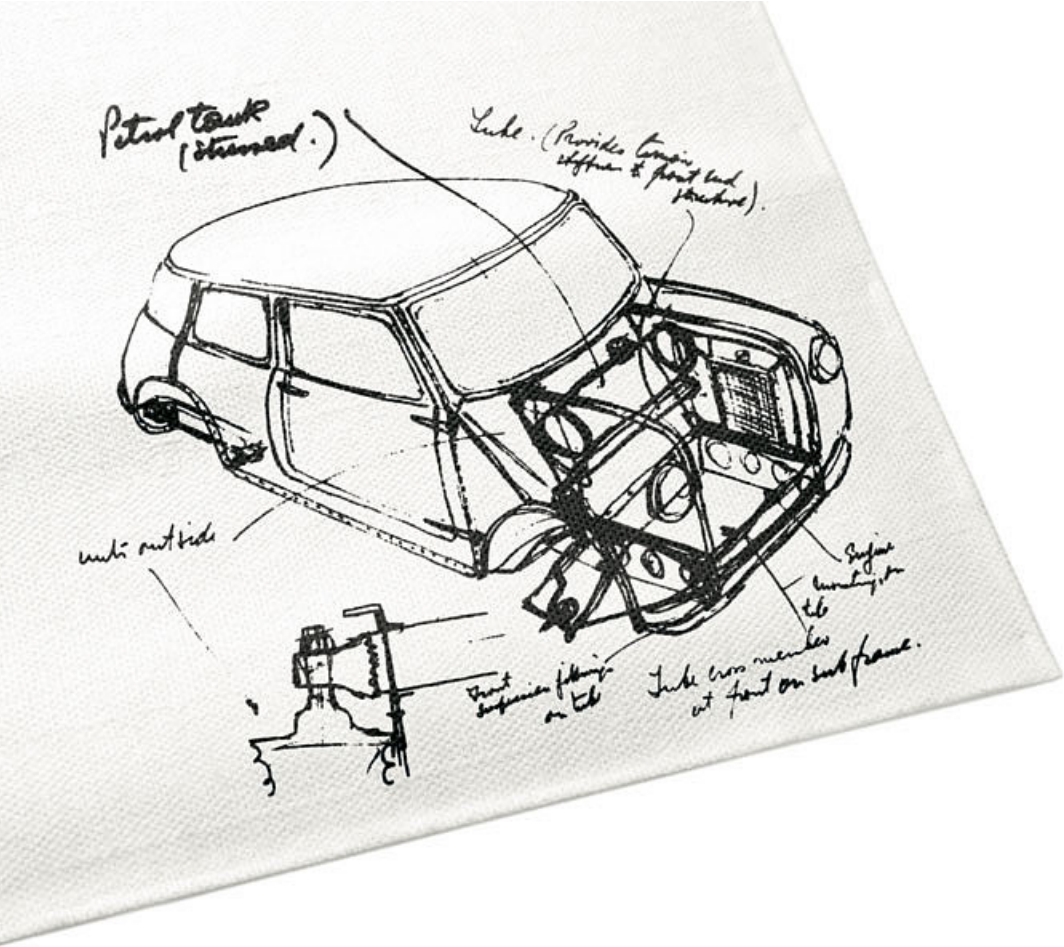

MAKING THE MINI: BREAKING THE MOULD.

When Sir Alec Issigonis sketched his initial idea for the Mini on a tablecloth in 1956, his innovative compact design was the perfect response to some of the biggest automotive questions of his era. Almost everything about it was unconventional: he increased the track width as far as he could, mounted the engine transversely, and positioned the instrument cluster centrally for both left and right-hand drive. This ensured maximum space inside the car. The concept was unprecedented – and his revolutionary Mini soon became an icon.

The first ever Countryman available to buy was the Austin Mini Countryman in 1960. A roomy estate with a long wheelbase and robust wooden appliqué, it was designed for trips through the country. With more space than usual and all the charm of a classic Mini, it won fans the world over.

Motorsport legend John Cooper saw star racing potential in the original Mini – so he created a model for the track. Braking, inducing oversteer and then drifting around corners became effortless for rally drivers, thanks to its light weight and short overhangs. Racing around tight bends at high speed, now synonymous with the classic MINI go-kart feeling, laid the foundation for a succession of spectacular wins at the Monte Carlo rally. Here, the Mini proved that agile handling beats sheer power, every time. To honour Cooper’s vision, the thoroughbreds of the MINI range bear the name John Cooper Works.

The compact design of Alec Issigonis and racing pedigree of John Cooper have defined the Mini from the very beginning and remain hallmarks of every iteration to this day. Their legacy of innovation lives on in the latest MINI – and the cutting-edge technology within.







DISCOVERY IS DESTINY.

You'll feel it in the first few metres: as big as it feels on the inside, the Countryman is still a MINI through and through. Gliding through the city, coasting through the mountains – it's all effortless. It's just under 4.3 metres long, which means it has some serious luggage capacity in addition to ample legroom. There's also a range of built-in features designed to make epic tours even easier and breezier, like the picnic bench, MINI Connected and the MINI Find Mate.

THE ONLY THING THAT SHOULD STOP YOU IS THE VIEW.

Main roads will only take you so far. Where the tarmac ends, the adventure really begins. And in the MINI Countryman, the only thing that's going to stop you is the view. Luckily there's a cushioned picnic bench for moments just like these. Just pull it out from beneath the loading shelf and soak up the sunset.

The loading shelf, fastening straps and lashing eyes in the optional storage package keep luggage in place and ensure optimal weight distribution. The luggage compartment also comes with extra LED lights and a 12-volt socket – perfect for powering a coolbox.



LUGGAGE, MEMENTOS, MEMORIES ...

Destined for higher things: If the luggage space available somehow isn't enough, you can find even more storage options in the high-quality MINI Original Accessories range, like the roof rail system for the luggage rack and roofbox.

ORIGINAL MINI ACCESSORIES
mini.com/accessories



... TAKE IT ALL WITH YOU.



Great views guaranteed: The optional panoramic glass roof provides a clear view of the sky above and makes the interior feel roomier. The front section opens and slides back electronically. If it gets too bright, there's also a blind for the tinted glass.



You can use the luggage space in the MINI Countryman in any number of ways: the load-compartment floor folds away and the rear backrests fold down in a 40:20:40 split. The rear seat bench slides forward to provide even more room, and splits in a 40:60 arrangement.

Luggage area, width x height x depth:
859 x 718 x 813 mm
Through-loading depth with rear seats
folded down: 1595 mm

The backlighting of the three MINI Yours Interior Styles comes into its own in darkness, bringing an atmospheric glow to the inside of your MINI at night.

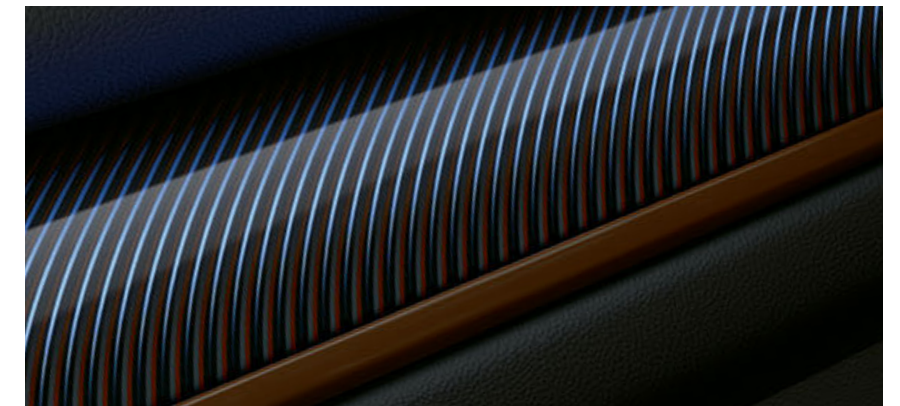

FIND YOUR COUNTRYMAN.

On the following pages, you'll get your first look at all the ways in which you can personalize your MINI Countryman. Let's start with the essentials: the engine room.

You can choose from 3 turbocharged petrol and 3 turbocharged diesel engines, or go for a cutting-edge plug-in hybrid with 6-speed Steptronic transmission and electric ALL4 all-wheel drive. All engines use the powerful and efficient MINI Twin Power Turbo technology.

MINI Countryman models are fitted with a track-style sequential 6-speed manual gearbox as standard. All engines are available with a Steptronic automatic gearbox on request. What's more, intelligent ALL4 all-wheel drive in the Cooper/D and Cooper S/SD models ensures optimum traction on all road surfaces. See page 36 for details. For a quick and easy model overview, see the fold-out page on the right.

Optional MINI Driving Modes adapt the performance of your MINI to match your mood and the road conditions. In the MID and GREEN modes, optional Dynamic Damping Control softens the suspension to keep the drive enjoyably smooth. If you want to feel like you're tearing up tarmac in a go-kart, select SPORT mode.

Pictured right: the Cooper in the exclusive Chestnut paint finish (for MINI Countryman only), with roof rails and side-skirt attachments in satin white aluminium, plus 19" MINI Yours Masterpiece light-alloy wheels in exclusive Dark Spectre Grey with burnished rims.

Details of fuel consumption and CO₂ emissions for all models, as required under EU law, can be found in the "Technical data" section beginning on page 48.





ONE.

The adventure starts here. Choose from a 1.5-l 3-cylinder petrol engine that delivers 102 hp/75 kW or a 1.5-l 3-cylinder diesel unit with an output of 116 hp/85 kW. Both feature MINI Twin Power Turbo technology. High-gloss Black finish for the fins on the radiator grille, side scuttles and tailgate handle trim. Exterior mirror caps in Matt Black.

COOPER.

A 1.5-l 3-cylinder petrol engine (136 hp/100 kW) and a 2.0-l 4-cylinder diesel version (150 hp/110 kW) offer a handy blend of oomph and economy. A classic MINI contrast colour is available at no extra cost for the roof and exterior mirror caps. The exhaust pipe comes with a Chrome trim. Bonnet stripes available on request.

COOPER S.

Better, faster, stronger: With a 2.0-l 4-cylinder petrol engine (192 hp/141 kW) or a 2.0-l 4-cylinder diesel unit (190 hp/140 kW), the Cooper S packs the biggest punch. Hallmarks include the red S at the rear, side scuttles and the mesh radiator grille with inner Chrome trim. Twin Chrome-plated exhaust pipes (right and left). MINI ALL4 Exterior Optic package available on request.

COOPER S E ALL4.

Slick combo: A 3-cylinder petrol engine (136 hp/100 kW) at the front with an 88-hp/65-kW e-motor at the rear axle. Instantly recognizable via the yellow MINI Plug-in Hybrid logo on the side scuttles and at the rear. Charging port at left side scuttle. Yellow "S" on the front grille and tailgate. Single Chrome-plated tailpipe at rear apron on the left-hand side.





FAST-FORWARD TO THE FUTURE.

The MINI Countryman Plug-in Hybrid combines an electric motor and battery with a conventional petrol engine to offer drivers the best of both worlds. Thanks to its high-voltage, lithium ion battery, the Plug-in Hybrid can drive electric-only and virtually emission-free for up to 41 km. The e-motor backs up the petrol engine via the boost function and enables electric all-wheel drive.

The central display (1) shows the power distribution between the two engines. A combi display (3) replaces the rev counter, and shows the available power. The battery can be charged both during the journey and externally at any 230-volt power supply via the supplied cable (2). A full charge (from 0%) takes up to 195 minutes. The MINI Countryman Plug-in-Hybrid offers emission-free fun out on the road, at practically no cost to space or practicality.

MINI ELECTRIC



FIND OUT ALL THAT WE'VE PACKED IN.

If the practically endless list of individual equipment options puts your head in a spin, keep things simple. Spruce up your MINI Countryman with one (or more) of our equipment packages. The features in each bundle have been carefully grouped together to complement each other – making your decision that much easier.

What's more, you can easily combine the four options here with other packages, like the MINI Connected, John Cooper Works, MINI ALL4 Exterior Optic (p. 32) and Chrome Line Exterior/Interior bundles.

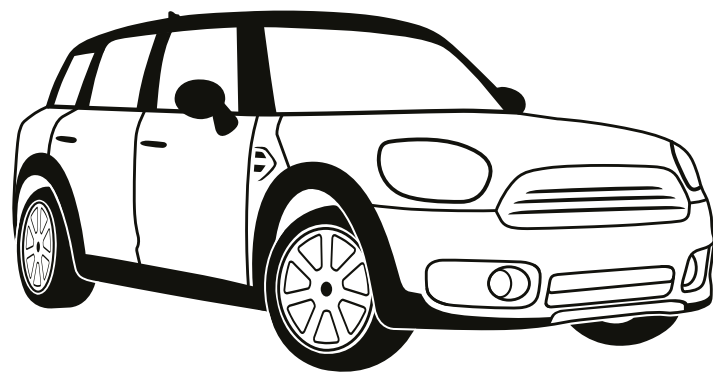

- | | | | | |
|---|---|---|---|-------------------------|
| ● | ○ | ○ | ○ | SALT. |
| ● | ● | ○ | ○ | PEPPER. |
| ● | ● | ● | ○ | CHILI. |
| ● | ● | ● | ● | JOHN COOPER WORKS TRIM. |

The Salt, Pepper, Chili and John Cooper Works Trim packages vary in size, each expanding on the one before it (see above). They contain complementary combinations of individual equipment options designed to suit your needs. See the fold-out page on the right for details. For information on availability, check online or contact your nearest MINI dealer.

mini.com





SALT.

The Salt equipment bundle adds a dash of extra comfort and connectivity to the mix. It includes velour floor mats, the lights and storage packages, automatic air conditioning and fog lights.

PEPPER.

Spice things up a bit with the Pepper package. It has everything in the Salt bundle plus the MINI Excitement package: ambient lighting with toggle switch in the headliner, waterfall lighting, lighting for door handles and MINI logo projection. You also get:

- + Keyless Comfort Access system
- + Sports leather steering wheel
- + Front armrest
- + Exterior mirror caps in body colour (for One/D)
- + 17" Imprint Spoke wheels (for One/D and Cooper/D)

CHILI.

On top of all the extras in the Salt and Pepper bundles, the Chili package packs even more racetrack flair and cutting-edge technology into your MINI. Here's what you get:

- + Cord cloth/leather sport seats
- + MINI Driving Modes
- + Cruise control with brake function
- + LED headlight technology with adaptive light distribution and fog lights
- + 17" Channel Spoke wheels (for One/D and Cooper/D)
- + 18" Pair Spoke wheels (for Cooper S/SD)

JOHN COOPER WORKS TRIM.

This package combines Salt, Pepper and Chili selected exterior and interior elements from the John Cooper Works range. The result is a totally sporty look and feel with:

- + John Cooper Works leather sports steering wheel
- + John Cooper Works Dinamica/cloth sports seats, Carbon Black
- + Performance Control (One/D and Cooper/D)
- + Sports rear roof-spoiler
- + John Cooper Works aerodynamic kit
- + Headliner in Anthracite
- + Stainless-steel pedals and footrests
- + John Cooper Works door sill finishers and gear lever knob
- + Sports suspension available on request (no charge)
- + Park Distance Control, rear
- + 18" John Cooper Works Thrill Spoke wheels

DIFFERENT SHADES OF ADVENTURE.



Standard colour Moonwalk Grey

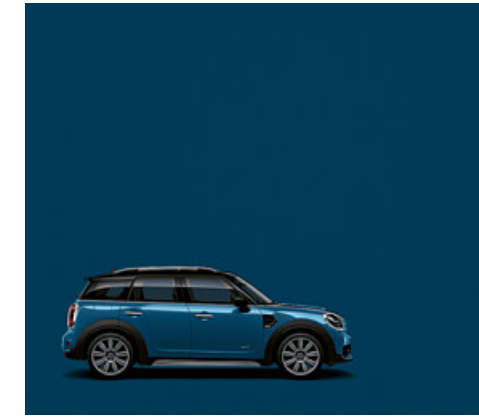

Island Blue

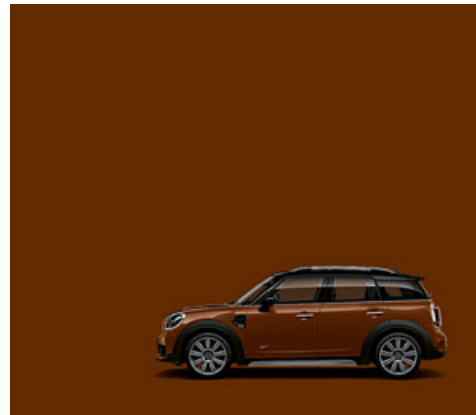

Chestnut

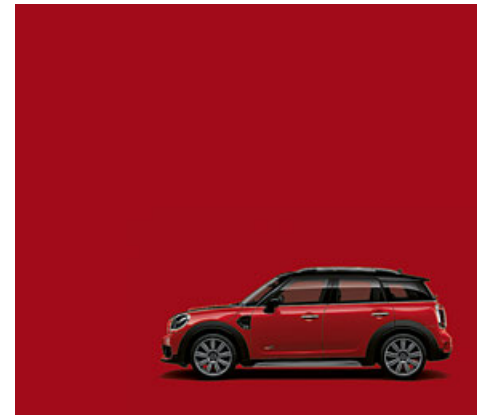

Chili Red

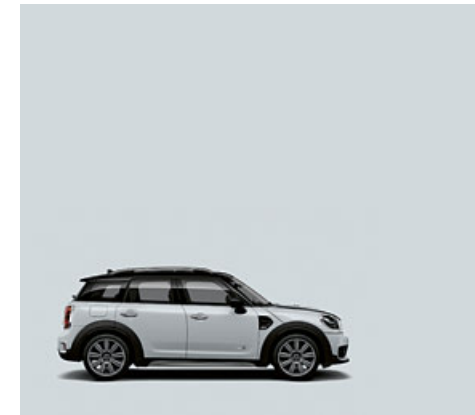

Light White



Melting Silver

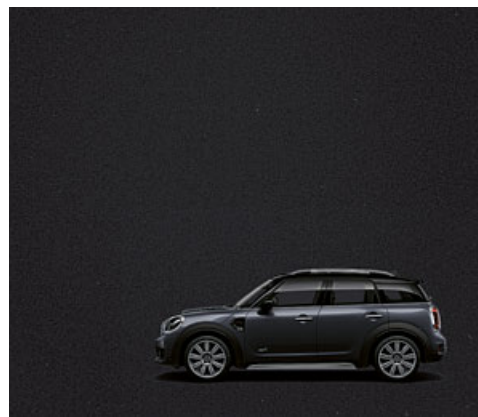

Thunder Grey

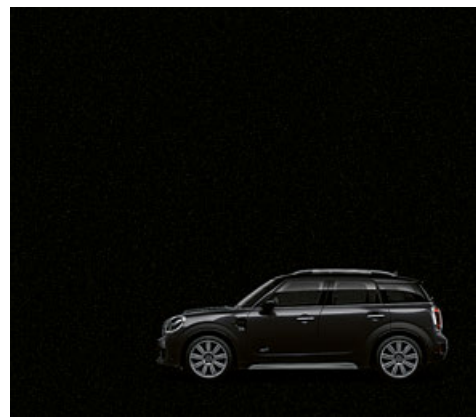

Midnight Black

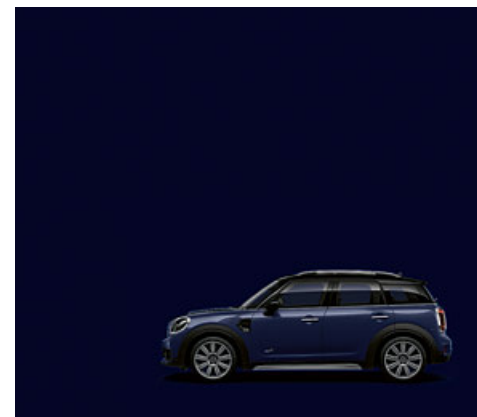

Exclusive finish: MINI Yours Lapisluxury Blue

Roof and exterior mirror caps.

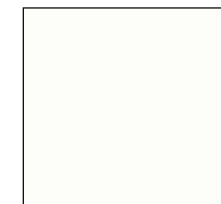

Aspen White



Jet Black

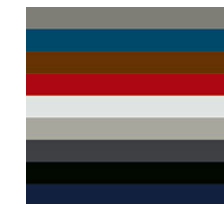

Body colour



12 WHEEL RIMS – ONE DECISION.

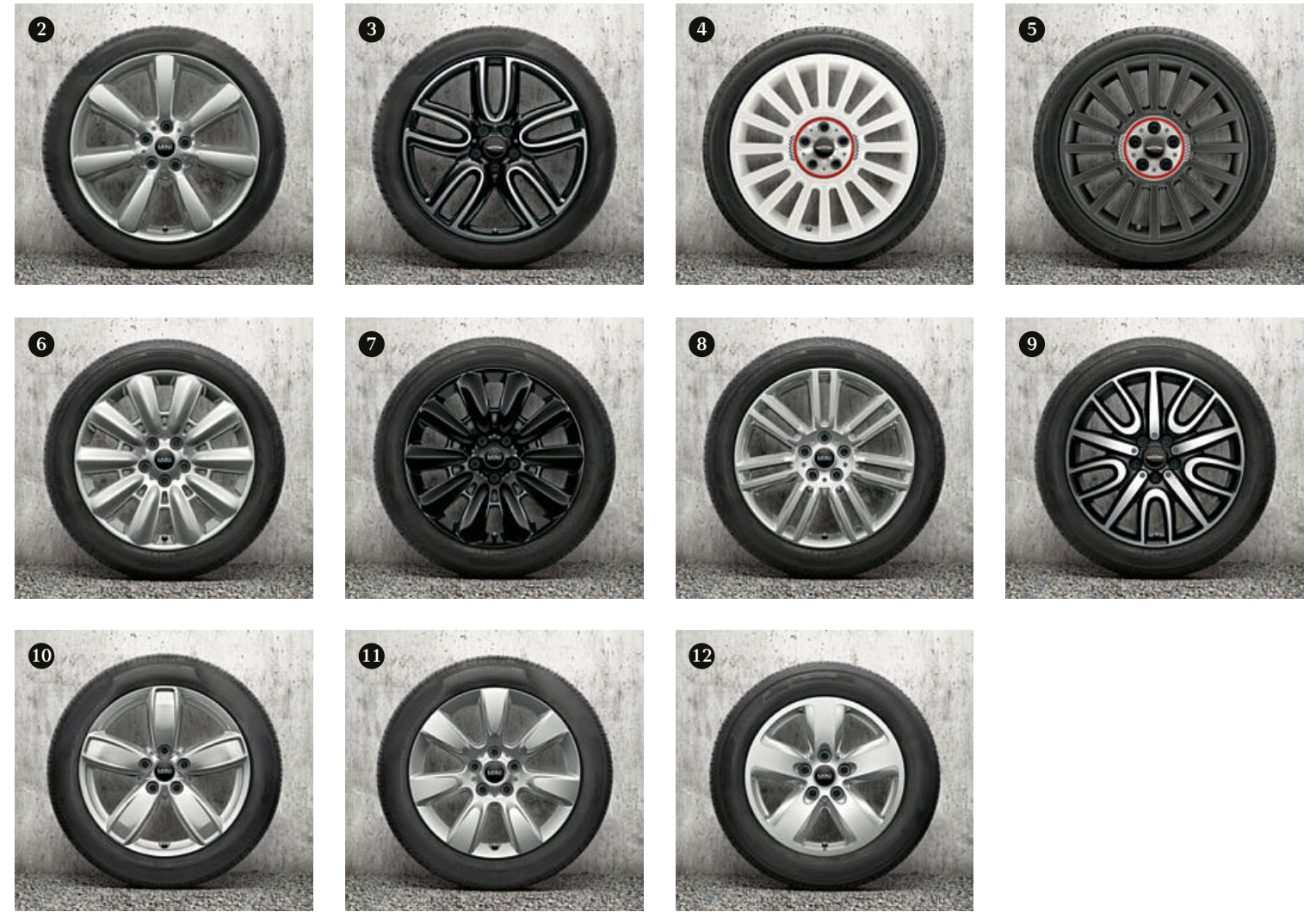

- ❶ 19" MINI Yours Masterpiece, burnished
- ❷ 19" Edged Spoke
- ❸ 19" John Cooper Works Course Spoke, burnished
- ❹ 19" John Cooper Works Rally Spoke 536 Bicolor (Aspen White, burnished)*

- ❺ 19" John Cooper Works Rally Spoke 536 Bicolor (Orbit Grey matt, burnished)*
- ❻ 18" Pin Spoke
- ❼ 18" Black Pin Spoke
- ❽ 18" Pair Spoke
- ❾ 18" John Cooper Works Thrill Spoke, burnished Anthracite

- ❿ 17" Channel Spoke
- ⓫ 17" Imprint Spoke
- ⓬ 16" Revolite Spoke

* Available from mini.com/accessories



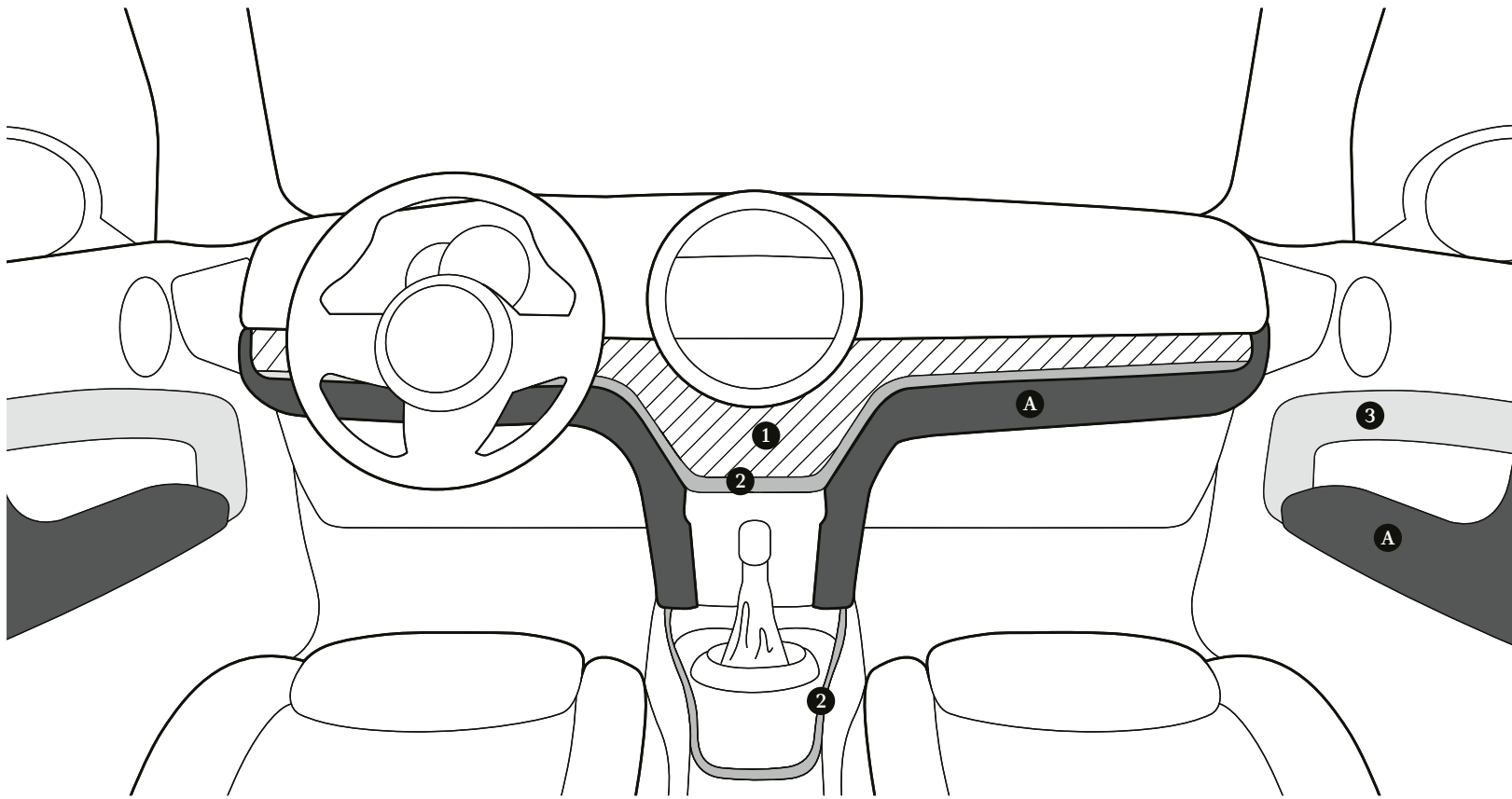

THE INTERIOR: IT'S ALL YOURS.

4 high-quality Interior Styles are available for personalizing the inside of your MINI – 3 of them with MINI Yours Illumination. Choose a style for the central design elements: decorative cockpit trim (1), a coordinating contrast trim (2) and the decorative door trims (3). Then select a suitable colour from the Colour Line range (A) for the kneepads and the armrests in the doors. The fold-out page on the left has all the details of the Piano Black Interior Style in combination with the British Oak Colour Line; the fold-out on the right shows the MINI Yours Chestnut illuminated Interior Style with the Carbon Black Colour Line.

The 4 optional Interior Styles.

Piano Black Interior Style.



Piano Black



Dark British Oak



Piano Black

MINI Yours Piano Black illuminated Interior Style.

(Illumination colours defined by ambient lighting in pin-stripe pattern)

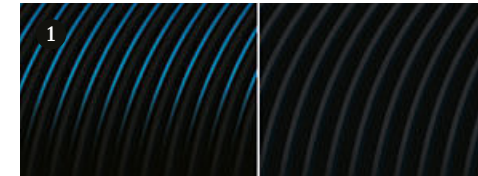

Piano Black illuminated, Piano Black



Hazy Grey

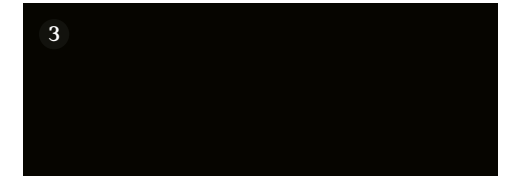

Piano Black

MINI Yours British Oak illuminated Interior Style.

(Red and blue graphics for illumination colours. Painted and backlit plastic surfaces. No real wood.)

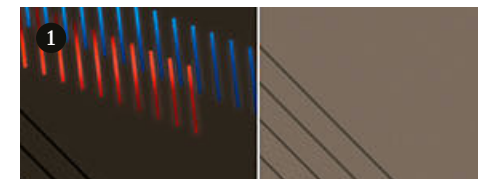

British Oak illuminated, British Oak



Hazy Grey



British Oak

MINI Yours Chestnut illuminated Interior Style.

(Illumination colours defined by ambient lighting in pin-stripe pattern)

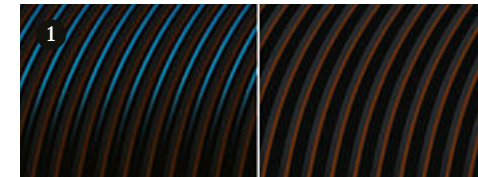

Chestnut illuminated, Chestnut



Chestnut

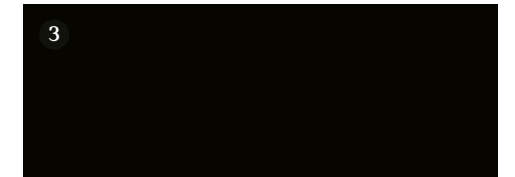

Piano Black

The 4 Colour Lines.



Malt Brown



Satellite Grey



British Oak



Carbon Black

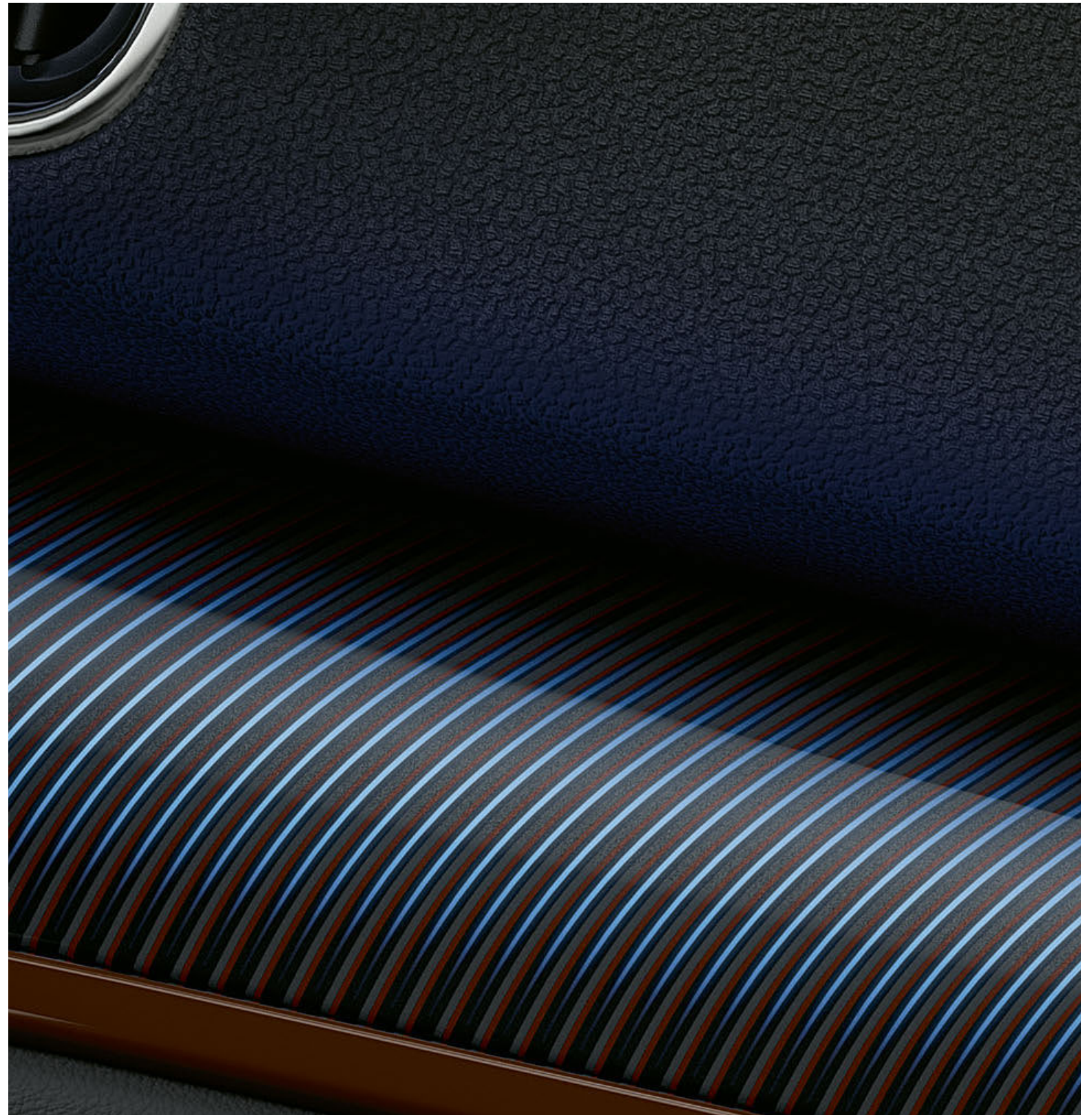

THE EDGE OF YOUR SEAT HAS NEVER BEEN SO COSY.



Chester leather
sport seat,
British Oak



John Cooper Works
Dinamica/leather
sport seat,
Carbon Black

AT HOME IN SECONDS.



Cross Punch leather*
sport seat,
Carbon Black



Cord cloth/leather
sport seat,
Carbon Black



Black Pearl cloth/leatherette
sport seat,
Carbon Black



Lounge leather*
sport seat,
Satellite Grey



MINI Yours Lounge leather*
Carbon Black,
incl. Dinamica armrests in
Carbon Black

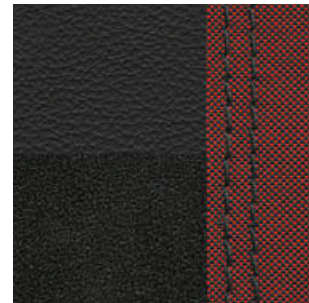

John Cooper Works
Dinamica/leather,
Carbon Black,
incl. Dinamica armrests in
Carbon Black



Lounge leather*
Satellite Grey,
incl. leatherette armrests in
Carbon Black



Chester leather*
British Oak,
incl. leatherette armrests in
Carbon Black



Cross Punch leather*
Carbon Black,
incl. leatherette armrests in
Carbon Black

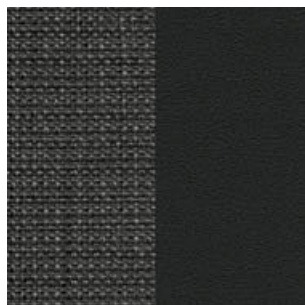

Black Pearl cloth/leatherette
Carbon Black,
incl. Black Pearl armrests in
Carbon Black

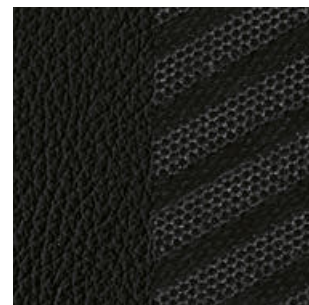

Cord cloth/leather
Carbon Black,
incl. Cord armrests in
Carbon Black

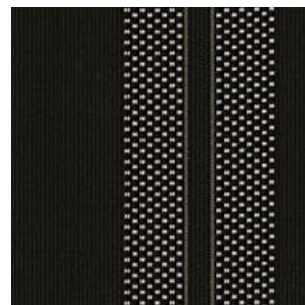

Double Stripe cloth
Carbon Black,
incl. Carbon Black armrests

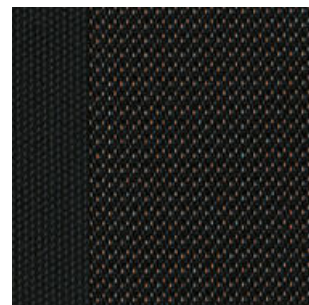

Firework cloth
Carbon Black,
incl. Carbon Black armrests



The optional electric front seat adjustment features a memory function that remembers your favourite seating position, including armrest, recline and lumbar support.



MINI YOURS.

The Carbon Black MINI Yours seat in luxurious Lounge leather isn't just made – it's crafted. The smooth feel of the leather against your hand, the detailed stitching of the Union Jack in the headrest, the braided edging ... the beauty is in the detail.

mini.com

* Leather upholstery includes seats (base and backrest), and front and rear headrests.



BIG ON SMALL DETAILS: MINI YOURS.

The MINI Yours customization programme provides a wealth of options for those who prize individuality and refined style. The range represents the best of British craftsmanship, and each item has its own story to tell.

Here are a few examples: the MINI Yours sports leather steering wheel including soft nappa leather and contrast stitching, burnished 19" MINI Yours Masterpiece wheel rims, illuminated MINI Yours Interior Styles and the spectacular exterior colour MINI Yours Lapisluxury Blue – a deep shade of ultramarine.

The MINI Yours logo with Union Jack and sewing needle features on all MINI Yours leather upholstery. The MINI Yours seat in Carbon Black is made from the finest leather. It comes with braided edging, a Union Jack on the back of the headrest, plus dinamica armrests in the same colour.





MINI ORIGINAL ACCESSORIES: EXPERIENCE THE ADVENTURE YOUR WAY.



Equipped with MINI Original and MINI John Cooper Works accessories, you and your MINI Countryman will be ready for any adventure. The powerful LED additional headlights set against the black front radiator grill provide excellent visibility, while the ultra-light handcrafted JCW Carbon exterior mirror caps and the 19" JCW Rally Spoke 536 light in Bicolor (Orbit Grey matt, burnished), complete with JCW hub covers in

Chili Red, ensure a distinguished look. The compact bike carrier can safely transport two bikes with a combined weight of up to 60kg – and can even be folded up and stowed away in the luggage compartment to save space.

[mini.com/accessories](https://www.mini.com/accessories)

PUTTING THE COUNTRY INTO COUNTRYMAN.

The MINI ALL4 Exterior Optic package brings out the tireless off-road workhorse in the MINI Countryman. Bumper attachments in high-gloss Black and an underride guard feature at both the front and rear, while the roof rails and side skirts in satin white aluminium underscore the SAV's ready-for-anything profile. The package is also available without ALL4 all-wheel drive.

MINI Original Accessories
[mini.com/accessories](https://www.mini.com/accessories)



GO YOUR OWN WAY ...

The best views are at the top, and ALL4 gets you there. The intelligent all-wheel drive system provides supreme traction when you need it, down dirt tracks, cobbled streets or even across the snowy plains. Now you can really run wild.

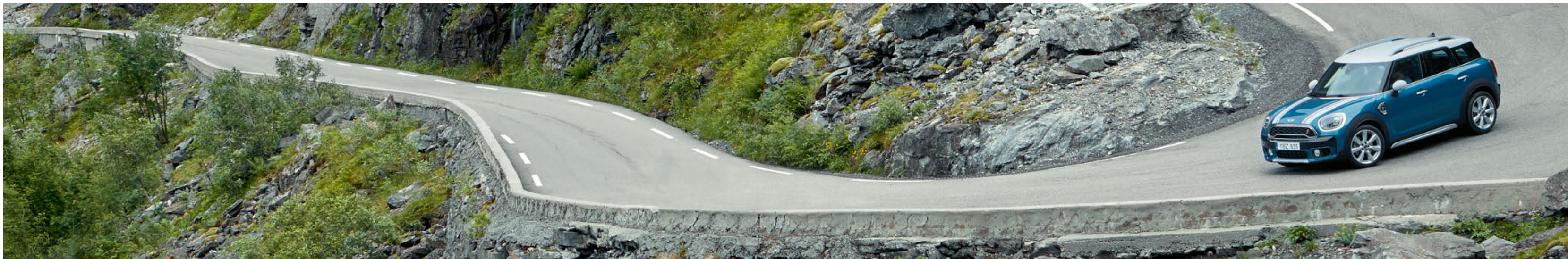

... WITH ALL4 ANYTHING'S POSSIBLE.

The ALL4 all-wheel drive in the MINI Countryman is an intelligent torque vectoring system that maximizes traction on virtually any surface. Its electro-hydraulic multi-disc clutch* is linked to Dynamic Stability Control and smoothly varies the amount of drive torque distributed from the MINI Twin Power Turbo engine to the front and rear axles according to the driving situation. That all means supreme traction, maximum stability and even more fun cruising around corners.

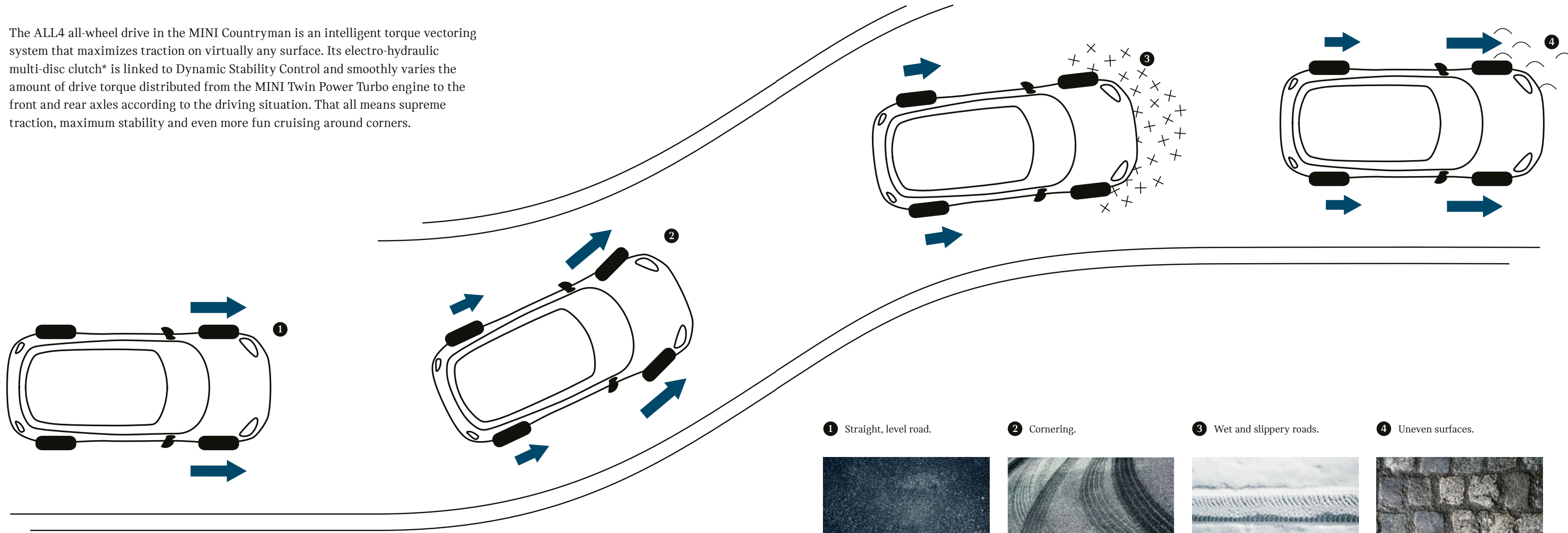

 Drive torque

1 Straight, level road.



To maintain efficiency in normal driving situations, e.g. on straight, level roads, the system diverts 100 % of the torque to the front axle.

2 Cornering.

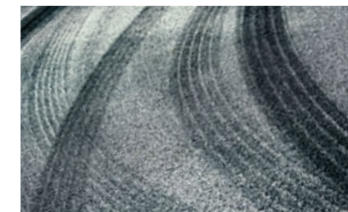

ALL4 allocates enough torque to the rear axle to counter the onset of over/understeer and increase stability.

3 Wet and slippery roads.



More torque is directed to the rear axle – in some cases up to 100 % – when a loss of grip occurs at the front. This counteracts understeer and ensures optimal traction.

4 Uneven surfaces.



ALL4 rapidly allocates the optimum amount of power to each axle to ensure maximum traction on uneven roads.

* Different ALL4 technology is used in the MINI Countryman Plug-In Hybrid (page 15).

THE BEST JOURNEYS BEGIN WITH PEACE OF MIND.

- 1 Never lose sight of the important things: The MINI Head-Up Display projects key driving information into the driver's line of sight without obstructing his view of the road. Depending on the optional equipment fitted, this data can include speed limits, navigation, or entertainment functions.
- 2 Your compatible iPhone is seamlessly integrated into the MINI Centre Instrument using the preparation for Apple CarPlay.

- 3 The optional Bi-LED light for the anti-dazzle and high-beam technologies is a clearly visible beacon out on the road. It's like having a lighthouse lamp fitted to your car. The LED cornering light follows and illuminates the curve of the road, while the LED fog lights and MINI Original LED additional headlights ensure optimum visibility when the weather takes a turn for the worse. Whatever the weather, the omega-shaped daytime running

lights in the LED headlights remain a hallmark of the MINI Countryman design. The High Beam Assist – part of the Driving Assistant – recognizes oncoming vehicles. At speeds of 50 km/h and above, it automatically switches the high beam off to prevent glare affecting oncoming traffic – and back on again once the vehicles have passed. It also recognizes when there is sufficient light, e.g. in built-up urban areas, and dims the lights accordingly.

- 4 If desired, the tailgate of the MINI Countryman can open and close electronically. All you need is the Comfort Access system: the Easy Opener function means you can open the boot just by waving your foot under the rear of the vehicle.
- 5 The Park Assist helps you find a suitable parking space and makes parallel parking easy. All you have to do is brake and accelerate as required.

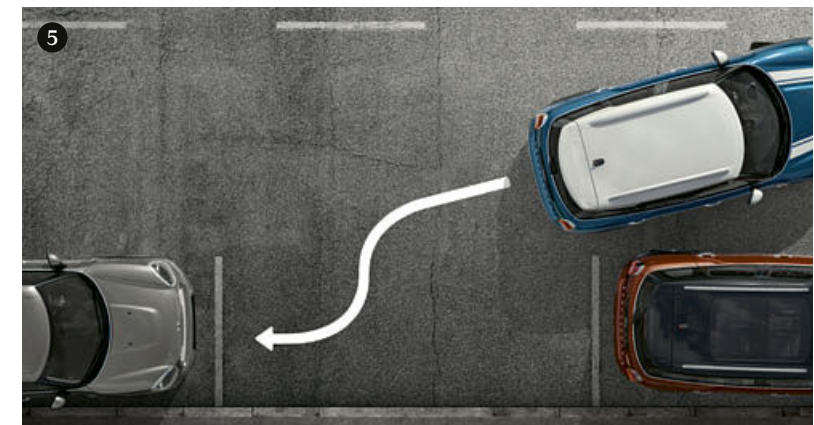



MINI CONNECTED: WELCOME THE WORLD.

MINI Connected is the perfect link between your MINI and your digital life. MINI Connected seamlessly integrates your smartphone, various smartphone apps and the MINI Connected app with your MINI – which is equipped with its own SIM card. So you have new ways of interacting with the car, including for example smart voice control, remote services or your personal concierge. All this, plus smart navigation that learns frequently visited destinations, takes real-time traffic information into consideration and gets you from A to B even more effectively.

The MINI Connected app is a mobile extension of your car that keeps you in touch with your MINI and what's happening around you. Use the app whenever and wherever you want to call up information about your MINI – and because its linked to the scheduler on your smartphone your MINI will notify you in good time when you have appointments coming up. All MINI Connected functions are being refined all the time, so every trip will be more exciting, more relaxed and more enjoyable than ever before.

mini.com/connected

Access all the benefits of MINI Connected with the Connected Navigation Plus option. It comes with the MINI navigation system with 22.4 cm/8.8" touchscreen plus alternative operation via the MINI Touch Controller on the centre console, and wireless charging. So you have in-car wireless charging and your phone connects to the car's external antenna. Along with many other online functions for networked navigation, the package includes online speech processing, MINI Connected XL and the Apple CarPlay ready kit.

MAKE YOUR WAY WITH EASE.

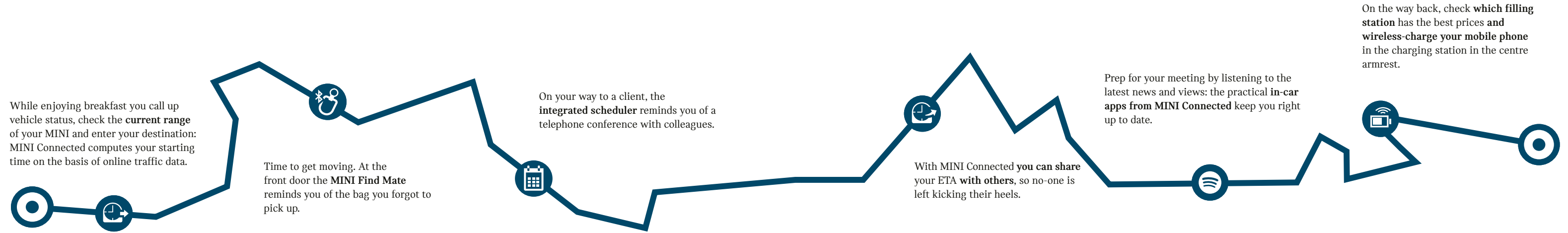

SELECTED INTERACTIVE FUNCTIONS.



REMOTE SERVICES AND VEHICLE STATUS.

Use your smartphone to unlock or lock your MINI, sound the horn and flash the high beams. The status display shows you where your MINI is, calculates the available range and, when you enter a destination, works out how long it will currently take you to drive there.



CONNECTED DRIVE SERVICES AND MINI ONLINE FUNCTIONS.

Use the MINI Connected Service apps to check fuel prices at filling stations, pick up messages and receive weather forecasts for your route and destination.



MINI FIND MATE.

Keep important items safe with a MINI Find Mate tag. As soon as your smartphone is too far away, the MINI Connected app issues a warning and shows you the last known location of the tagged item.



APPLE CARPLAY READY KIT.

The Apple CarPlay ready kit makes it easy for you to interconnect your iPhone with the display, the controls and the speakers of your MINI. Then you have many apps that you use on your iPhone available on your trip.



MINI CONCIERGE SERVICE.

You can access the MINI Concierge Service around the clock through your MINI Connected menu. The service will find the answers to your questions, look up addresses and transmit them to the car's satnav, even book hotel accommodation for you.



SPOTIFY.

A huge number of pre-configured apps for MINI Connected allow you to listen to your favourite music while you're on the move. Use Spotify to discover the latest releases, for example, and manage your personal playlists.

SELECTED FUNCTIONS FOR SMART NAVIGATION.



RTTI

REAL TIME TRAFFIC INFORMATION.

RTTI reports the momentary traffic situation and sends the data to the satnav. The system estimates the delay and suggests alternative routes.



ONLINE SEARCH.

Going shopping or eating out? Once you've found somewhere suitable using Online Search, you can send the address to the navigation system, and the phone number to your smartphone, so you can book a table.



FREQUENTLY VISITED PLACES AND SUGGESTED DEPARTURE TIMES.

MINI Connected lists visited, learned or saved destinations and checks the current driving time online. When it's time to leave for a planned destination, MINI Connected notifies you on your smartphone or Apple Watch.

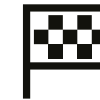

SEND DESTINATION FROM SMARTPHONE TO NAVIGATION SYSTEM.

As long as your smartphone is paired to your vehicle, destinations (learned, saved or imported from your calendar) are automatically saved to the navigation system. Route guidance starts automatically (depending on equipment fitted).



CALENDAR INTEGRATION.

MINI Connected can import all destinations from your smartphone calendar. Without any action on your part, it reminds you when it is time to get going and puts your destinations directly into the navigation system.



WIRELESS CHARGING.

Wireless charging automatically tops up the battery as soon as you lay your mobile phone in the charging station in the centre armrest. In this position it is connected directly to the car's external antenna for better voice quality. Most devices support both functions; check with your authorised MINI dealer for compatibility details.



YOUR MEANS OF COMMUNICATION.



1 STANDARD RADIO.

The standard radio has a 16.4 cm/6.5" screen, Bluetooth hands-free and audio streaming plus USB audio interface.



2 CONNECTED MEDIA.

Better connected to all services for networked visual radio: the MINI Visual Boost radio with 16.4 cm/6.5" screen, operation by touchscreen or MINI Controller, MINI Connected interface for operation by smartphone with the MINI Connected app.



3 CONNECTED NAVIGATION.

Appropriately networked to all data for better navigation: the high-end navigation functionality with 16.4 cm/6.5" screen with real-time traffic information, automatic online map updates, extended MINI Connected services and Apple CarPlay.



4 CONNECTED NAVIGATION PLUS.

Even more scope for maximum possibilities: the 22.4 cm/8.8" screen with splitscreen function, MINI Connected XL, wireless charging for mobile phone, second USB port and ergonomic MINI Touch Controller.

THE MINI FIND MATE.

Forget forgetting: Connected Navigation Plus includes a MINI Find Mate, a small Bluetooth tag for you to attach to important items. As soon as you go a certain distance away from the tagged item, the MINI Connected app sends a signal to your smartphone and if you want it will show you the way back to the item's last known GPS location. The MINI Connected app can administrate up to 6 MINI Find Mates. Get the Find Mates from MINI Lifestyle.

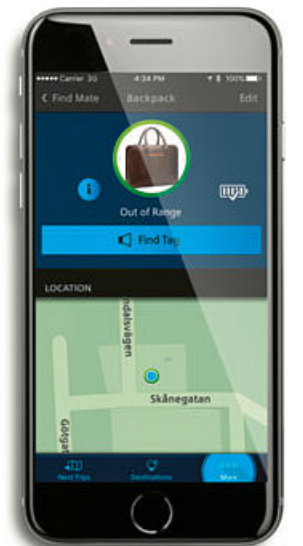



DRIVING THE FUTURE OF MOBILITY.

We have never been so connected – and life has never been so fast-paced. So we need vehicles that can keep up with our lifestyles. And this is why a MINI excels in many different ways. A MINI is all about being yourself, enjoying your journey and turning heads along the way. But it's also about having the right mindset. This means loving what we do. And recognising the value in certain things, whether it's because they mean something, because they're important or because they look good. Since 1959, we have strived to retain what sets MINI apart while creating something new. We want to inspire others to help us develop better ways of going places, which we can appreciate today – and in the future.

Recycling.

At every stage, from design to disassembly, recycling is central to the MINI philosophy. For example, all the materials used in each vehicle's manufacture are selected because they can be used in the most sustainable and environmentally friendly way possible. That way, every MINI can be efficiently and ecologically recycled when its driving days are finally done. We have been working on this approach since 1994 at the BMW Group Recycling and Disassembly Centre in Munich, Germany, the only facility of its kind. Your MINI dealer will be pleased to advise you on the disposal of your old vehicle, or you can visit [mini.com/recycling](https://www.mini.com/recycling)



MINI SERVICE.

For values that we pass on to others. MINI Service.

MINI Service partners share your passion. Entrust your MINI to our MINI Service partners. In electronics, mechanics, body work, paintwork and touch-up repairs, they have the skills to keep it in tip-top order. They use genuine MINI parts, to keep you safe and sound.

Just like in the good new times. MINI warranty extension.

Extend that new-car feeling. When you take out an extended warranty your new MINI is well covered even after the statutory warranty period expires. For up to 5 years. Worldwide! See for yourself – at mini.com

Everything taken care of. Passion is what's left. MINI Service Inclusive.

Now you only have to think about it once and never again. Take out MINI Service Inclusive coverage when you buy your new MINI. After that, for up to 6 years all the included servicing and maintenance work is taken care of by a single payment. No-worries driving, guaranteed! See for yourself – at mini.com

Your MINI calls in when it needs something. MINI Teleservices.

Always on the move, you can't think of everything, so let your MINI do it for you. With Condition Based Service you automatically get a reminder in the MINI Centre Instrument when the next service appointment is due. With MINI Teleservices the car automatically sends the essential vehicle data for the next condition-based service directly to MINI. Your MINI Service dealership of choice gets the data and contacts you to arrange a date and time for a visit to the workshop – if necessary. The only prerequisite: you must have the "MINI Connected" or "intelligent emergency call" option and a vehicle registered in the MINI Connected app or, as of May 2018, a vehicle registered in the MINI Connected online portal (subject to availability). If you decide you don't need MINI Teleservices you can deactivate the setting whenever you want. More at mini.com

We keep your MINI mobile. MINI breakdown and accident assistance.

24 hours a day – 365 days a year: The MINI breakdown and accident assistance service is always there in case you need it. We have an extensive country-specific mobility offering for breakdown assistance. We offer insurance coverage for accident and theft. Specially trained MINI technicians provide solutions by phone or in the field. Round the clock and round the world. Find out more – at mini.com



MINI FINANCIAL SERVICES.

The key to the car of your dreams.

MINI Financial Services* represents the quickest way to the car of your dreams. With MINI Leasing, you pay to use the vehicle and not a penny more. MORE MINI packages provide a host of attractive extras, such as suitable insurance**, a tailored service deal or even a combination of both.

If you want to own a MINI but stay flexible with your financing, you'll find a favourable deal with MINI Finance. And for total peace of mind, check out MINI Car Insurance.**

Find out more about MINI Financial Services online at mini.com or visit your local MINI dealership.***

* MINI Financial Services is a trade name of BMW Bank GmbH, Heidemannstr. 164, 80939 Munich, Germany.
** Contractual partner and risk carrier is Allianz Versicherungs-AG.
*** Vehicle also includes a service package. See service package agreement for details.

Warranty.

Every MINI is supplied with a 2-year dealer warranty against manufacturing defects. The MINI dealership where the purchase was made is responsible for honouring the warranty. Repair work can be carried out at any authorised MINI dealer, MINI Service Authorised Workshop or any other service centre authorised by MINI. Defects arising in the first 6 months after purchase are deemed by law to have existed at the time of purchase and the dealer has the onus of proving that the vehicle is not defective due to a manufacturing defect. Every MINI also comes with a 12-year anticorrosion warranty, which covers the vehicle against rusting of the body panels. The painted surfaces of the car are covered by a 3-year warranty. This warranty does not cover damage to the vehicle body or under-body caused by stone impacts, scratches or dents, accident damage or other damage caused by environmental factors. Failure to comply with the service schedule provided by the manufacturer may invalidate this warranty.

TECHNICAL DATA FOR THE MINI COUNTRYMAN.

Engine ^{1,2}		One	One D	Cooper (ALL4)	Cooper D (ALL4)	Cooper S (ALL 4)	Cooper SD (ALL4)	Cooper S E ALL4
Cylinders/configuration/valves per cylinder		3/in-line/4	3/in-line/4	3/in-line/4	4/in-line/4	4/in-line/4	4/in-line/4	3/in-line/4
Displacement	cc	1499	1496	1499	1995	1998	1995	1499
Stroke/bore	mm	94.6/82	94.6/82	94.6/82	90/84	94.6/82	90/84	94.6/82
Nominal power/rated speed	kW/hp/ rpm	75/102/ 3900-6500	85/116/ 4000	100/136/ 4500-6500	110/150/ 4000	141/192/ 5000-6000	140/190/ 4000	100/136/ 4400-6000
Max. torque/revs	Nm/rpm	190/1380-3600	270/1750-2250	220/1480-4100	350/1750-2500	280/1350-4600	360/1500-2750	220/1250-4300
Compression ratio/fuel	:1	11/91-98 RON	16.5/diesel	11/91-98 RON	16.5/diesel	11/91-98 RON	16.5/diesel	11/91-98 RON
Performance⁴								
Max. speed	km/h	180 [180]	190 [188]	200 [200] (197 [197])	208 [208] (205 [205])	225 [225] ([222])	[220] ([218])	[198]
Electric max. speed	km/h	-	-	-	-	-	-	[125]
Acceleration 0 - 100 km/h	s	12 [12.3]	11.2 [11.2]	9.7 [9.7] (10.3 [10.1])	9.1 [9.1] (9.0 [9.0])	7.6 [7.5] ([7.6])	[7.9] ([7.6])	[6.8]
Acceleration 80 - 120 km/h (5th gear)	s	14.4 [-]	12.1 [-]	11.2 [-] (12.3 [-])	9.3 [-] (9.3 [-])	8.6 [-] (-)	[-] (-)	-
Consumption^{1,2}								
Combined (PHEV weighted)	l/100km	7.3-6.8 [7.5-7.1]	5.5-4.9 [5.5-5.0]	7.3-6.8 [7.6-7.1] (7.8-7.0 [8.0-7.2])	5.7-5.2 [5.9-5.5] (6.1-5.7 [6.1-5.6])	7.8-7.4 [7.9-7.4] (8.2-7.8)	[6.0-5.6] ([6.2-5.8])	3.2-2.9
Electricity consumption	kWh/100 km	-	-	-	-	-	-	14.0-13.4 ⁵
CO ₂ emissions, combined (PHEV weighted)	g/km	165-155 [171-161]	143-129 [143-131]	165-155 [173-161] (175-158 [181-162])	148-136 [155-143] (161-149 [159-148])	177-168 [179-167] (187-177)	[157-146] (162-152)	72-66
Exhaust emissions standard (type-certified)		EU6d-temp	EU6d-temp	EU6d-temp	EU6d-temp	EU6d-temp	EU6d-temp	EU6d-temp
Fuel tank capacity	l	51	51	51	51	51	51	36
Weight⁴/luggage capacity⁴								
Unladen weight. (EU) ⁴	kg	1455 [1485]	1505 [1530]	1460 [1490] (1550 [1565])	1530 [1560] (1605 [1625])	1525 [1540] (1625)	[1585] (1650)	[1760]
Max. permitted weight	kg	1950 [1980]	2010 [2020]	1955 [1985] (2050 [2065])	2045 [2075] (2125 [2145])	2020 [2040] (2130)	[2105] (2170)	[2270]
Max. permitted load	kg	570 [570]	580 [565]	570 [570] (575 [575])	590 [590] (595 [595])	570 [575] (580)	[595] (595)	[610]
Max. permitted axle load, front/rear	kg	1005/990 [1040/985]	1040/1025 [1065/1025]	1015/985 [1045/980] (1060 [1080])/ (1030 [1030])	1075 /1015 [1110/1010] (1110 [1130])/ (1055 [1060])	1055/1000 [1070/1000] (1010/1050)	[1110/1030] (1130)/(1070)	[1115/1200]
Luggage capacity	l	450-1390	450-1390	450-1390	450-1390	450-1390	450-1390	405-1275
Wheels								
Tyre dimensions, front/rear		205/65 R16 95W	205/65 R16 95W	205/65 R16 95W	205/65 R16 95W	225/55 R17 97W	225/55 R17 97W	225/55 R17 97W
Rim dimensions, front/rear		7J x16 LM	7J x16 LM	7J x16 LM	7J x16 LM	7.5J x17 LM	7.5J x17 LM	7.5J x17 LM
eDrive/system performance								
Output (eDrive)	kW/hp	-	-	-	-	-	-	65/88
System output	kW/hp	-	-	-	-	-	-	165/224
System torque	Nm	-	-	-	-	-	-	385
Electric range (NEDC) ³ /max. total range, combined ³	km	-	-	-	-	-	-	-
Battery type/net capacity	kWh	-	-	-	-	-	-	Li-Ion/6,1

MINI COUNTRYMAN DIMENSIONS.

Cooper S/SD figures in brackets. All figures are in millimetres (mm).

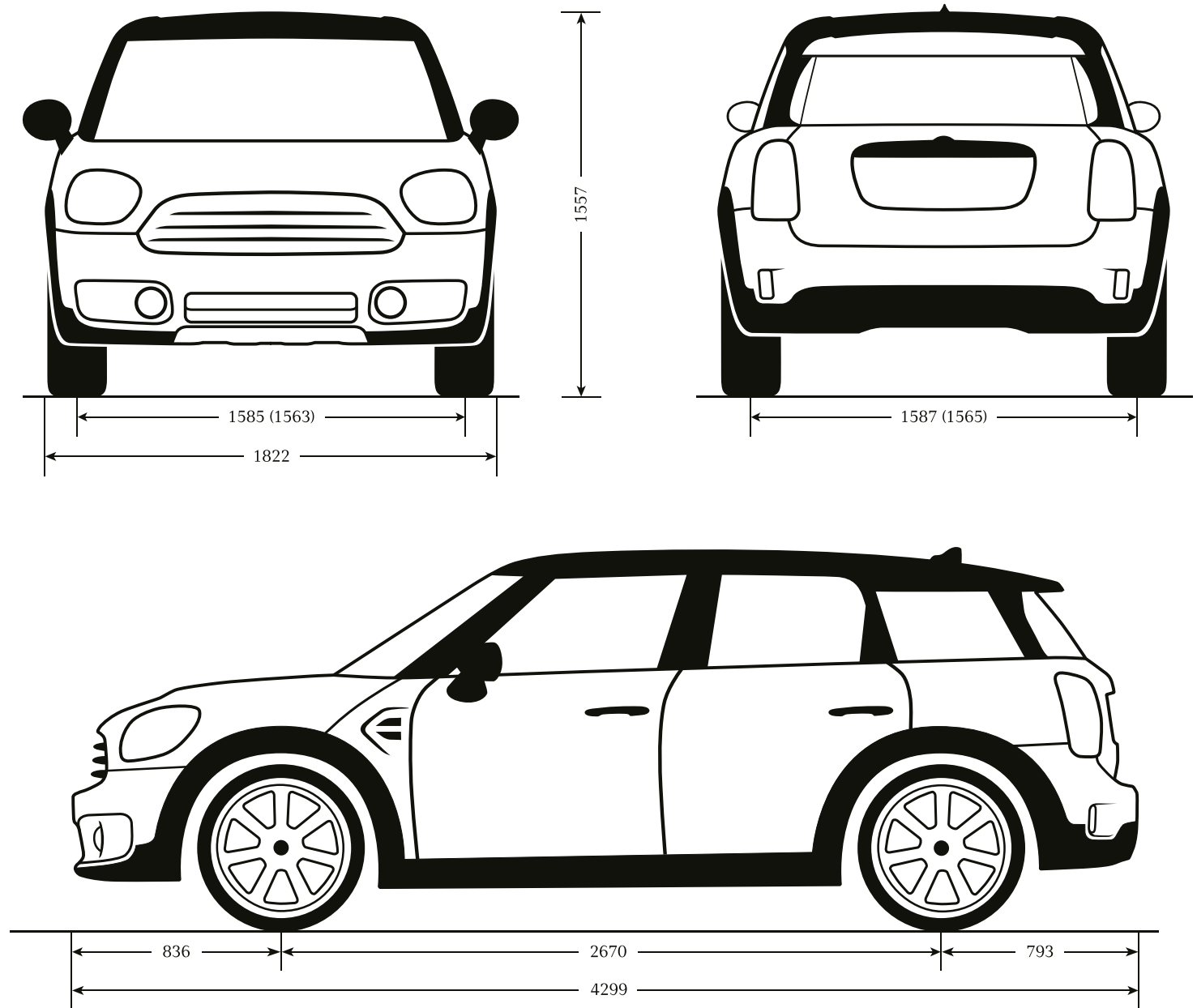

¹ All figures relate to vehicles with the standard 6-speed manual transmission. Values in [] relate to vehicles with 7-speed/8-speed Steptronic transmission.
² The values shown for fuel consumption, CO₂ emissions and energy consumption are calculated in accordance with the measurement method prescribed in the European Regulation (EC) 715/2007 in the version applicable at the time of approval. The figures refer to a vehicle with basic configuration in Germany and the range shown considers optional equipment and the different size of wheels and tyres available on the selected model and may vary during the configuration. The values are already based on the new WLTP test cycle and have been translated back into NEDC-equivalent values for the purpose of comparison. [For these models, different values to those shown here apply when calculating taxes and other vehicle-related duties that (also) focus on the CO₂ emissions.]
³ Range may vary due to factors such as driving style, road conditions, external temperature, heating and air conditioning, and preconditioning.
⁴ Assuming car is fuelled to 90% of tank capacity, and allowing 68 kg for the driver and 7 kg for luggage. The unladen weight quoted is for standard-specification vehicles. Optional equipment will increase this figure.
⁵ The lower value applies to the 17" and 18" standard wheels without runflat tyres (option 258).



THIS IS WHERE THE FUN REALLY STARTS.

What's the point of revving yourself up without taking it for a spin? Get behind the wheel. Make yourself comfortable in the driver's seat. Listen to the satisfying sound the door makes as it closes behind you. Fasten your seat belt. Adjust the rear-view mirror and start the engine. A whole new experience awaits you: a drive like no other, guaranteed to inspire. So what are you waiting for? Arrange a test drive with your MINI dealer and find out what it feels like to drive a MINI Countryman.

mini.com



The models, standard and optional equipment and combinability of options in this catalogue relate to cars supplied by BMW AG for the German market. The availability of standard and optional equipment, and configurations of options, may vary for all models in this brochure after going to press (on 20 December 2018) and may vary from country to country within the European Union. For detailed information about the situation in your country, please contact your authorized MINI dealer. Subject to changes in design and equipment.

© BMW AG, Munich, Germany. Not to be reproduced, wholly or in part, without the written permission of BMW AG, Munich.

Find out more online at:
mini.com



facebook.com/mini

MINI ORIGINAL ACCESSORIES
mini.com/accessories

MINI COLLECTION
shop.mini.com

March 2019

