



THE MINI 3-DOOR. THE MINI 5-DOOR.





## EXPLORE MORE CORNERS.

The MINI Hatch is made to enjoy urban life to the full. The sporty go-kart feeling makes it fun to drive around tight corners and make your own way through narrow lanes and heavy traffic with ease. All the while, the MINI Hatch stands out from the crowd thanks to its distinctive styling. Combined with the advanced MINI Connected features, these qualities are driving you forward to find the best places to be wherever you are. Go exploring.

For more information on the options available for each model contact your MINI dealer or visit [mini.com](http://mini.com)



Downtown is no place for the mainstream. With its long tradition of breaking rules, the MINI fits perfectly in this environment.

Details of fuel consumption and CO<sub>2</sub> emissions for all models, as required under EU law, can be found in the "Technical data" section beginning on page 52.

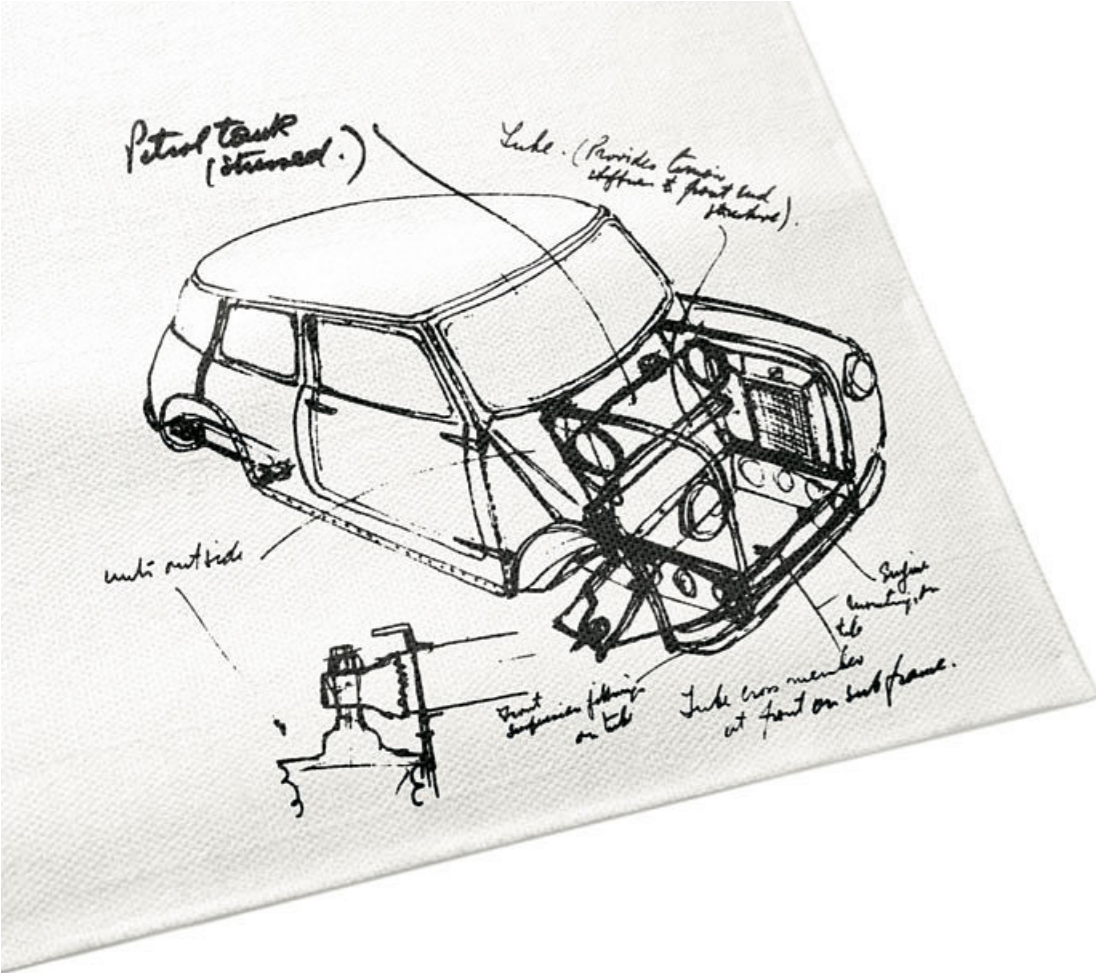

# THOROUGHLY DIFFERENT SINCE 1959.

Simple, innovative, fast: Alec Issigonis unleashed an automotive revolution with a sketch he roughed out on a napkin in his favourite restaurant. His Mini was unlike anything the competition had to offer – and technologically it was years ahead of its time. The radically new concept with transverse engine and front-wheel drive made the passenger compartment astonishingly roomy, and opened up unprecedented possibilities on the road.

From 1959 on, its striking appearance plus the roadholding of a go-kart quickly made the Mini the darling of the public. Its design reflected a modern attitude and appealed directly to the spirit of the times. And although originally intended by its creator as efficient transport for people in general, its enthusiasts included artists, celebrities and jet-setters. All the more so when race specialist John Cooper recognised the potential of the classic Mini for motorsport. Short overhangs and low weight were perfect for the spectacular drifting that earned the Mini Cooper innumerable rally wins over much more high-powered competitors. Every Mini ever since has been proof that nimble handling can beat sheer power hands down.



A big hit on small wheels: Alec Issigonis designed the original Mini to be the most modern car of its day. The public at large loved its efficiency and its roominess, whilst the sports version of the Mini by John Cooper left many a rally favourite in the dust.









New trends and creative ideas emerge where crowds of people are on the move and the traffic is heaviest – in the heart of the city. With its agile handling characteristics the MINI is right at home, and first to arrive.

Individuality is another field in which the MINI is ahead of the pack. As one of the first brands worldwide, MINI lets you design the accessories you want as one-offs. So you're a trendsetter not a follower – for example with innovative 3D printing technology. See page 30 for details.

Change is often the way to remain true to yourself, as evidenced by the new, evolved MINI logo.



## ALL DOORS OPEN.

When you opt for a MINI, you opt for choice: Is yours going to have 3 or 5 doors? Will it be a One, a Cooper or a Cooper S? Which equipment and trim line do you prefer? Which type of engine?

Before making up your mind, check out the possibilities on the following pages and see what the options are. And – not every decision has to be final. Because with the wide range of accessories you can restyle your MINI again and again.

Over the years the MINI has grown with the people who drive it and with their needs and preferences. But the core of its character is and remains the creative concept of Alec Issigonis, the designer who created the original Mini: compact dimensions, short overhangs, low centre of gravity and wide track for the sheer enjoyment of sporty driving, plus maximum manoeuvrability.

## BE DIFFERENT.

The bezels for radiator grille, headlights and rear lights in Piano Black are an exclusive option for the MINI Cooper S/SD, shown here on the right. The two-tone 18" Cup Spoke light-alloy wheels are part of the John Cooper Works Trim line. Picks from the accessories range: additional headlights in black (right) and carbon mirror caps (below).



Details like the side scuttles and the contrasting colours for roof and mirror caps emphasize the long-drawn roof line with sporty rear spoiler and the self-confident spirit of the car. Available on request: the 17" Propeller Spoke 2-tone light.

MINI original accessories  
[mini.com/accessories](http://mini.com/accessories)

The MINI 5-door seats five. There's more legroom for the rear passengers and 30% more space in the luggage compartment. The 5-door MINI Cooper in Chili Red shown here boasts Chrome Line exterior trim, white turn indicators and 18" Cone Spoke white light-alloy wheels for that rally-sport touch.



# FIRST CLASS REAR SEATS.



## The MINI 3-door.

The rear compartment of the MINI 3-door has comfortable single seats for 2 adults. ISOFIX child seat mountings are standard. The photo shows upholstery in leather Lounge Satellite Grey\* with pipe look.



## The MINI 5-door.

The rear compartment of the MINI 5-door seats 3 passengers. Here you see upholstery in leather Lounge Satellite Grey\*, armrests in the doors also in Satellite Grey and door trim strips in Piano Black. ISOFIX child seat mountings are standard for the two outer rear seats.

\* See page 32 for more details on leather trim.

# PERFORMANCE MEETS DESIGN.

Harking back to the classic Mini with the round speedo in the middle of the dashboard: the MINI Centre Instrument. 16.4 cm/6.5" display screen and Bluetooth telephony are standard features and there are three enhancement levels – from the touchscreen function and various user-friendly MINI Connected services to the big 22.4 cm/8.8" display screen of the Connected Navigation Plus option, complete with splitscreen display.

(Shown here is the Connected Navigation Plus with 22.4 cm/8.8" display screen)



The MINI Yours Piano Black illuminated interior surface with stylised Union Jack is backlit in the ambient colours available in the MINI Excitement package.

The gearshift lever for the optional double-clutch transmission with 7 speeds, or the 8-speed automatic transmission with Steptronic.





# ENGAGE YOUR ENGINE.

Each MINI model has its very own engine characteristic. But with 3 cylinders or 4, petrol or diesel\* – all MINI engines have one thing in common: their powerful and efficient MINI TwinPower Turbo technology.

A sporty, close-ratio 6-speed manual gearbox is the standard transmission in almost all MINI models. A 7-speed double-clutch transmission is available on request, with a sports-ratio characteristic an option for the Cooper S. The Cooper SD has an 8-speed automatic transmission with Steptronic as standard and again, extra-sporty close-ratio gearing is an option.

More variability is the hallmark of the adaptive suspension selectable in MINI Driving Modes. In SPORT mode the set-up is perceptibly stiffer for an even sportier go-kart feeling.



## MINI ONE.

Go-kart feeling starts with the 1.5l 3-cylinder petrol engine, MINI TwinPower Turbo technology and 55 kW/75 hp in the One First or 75 kW/102 hp in the One – or the 1.5l 3 cylinder TwinPower turbodiesel\* with 70 kW/95 hp. Signature features are the safety bar, tailgate handle strip and mirror caps in matt black and grill slats in black high gloss.

## MINI COOPER.

Dynamics and efficiency combined are the hallmark of the 1.5l 3-cylinder engines of the Cooper models: The petrol engine delivers 100 kW/136 hp and its diesel counterpart\* 85 kW/116 hp. Special features: Contrasting colour for roof and mirror caps possible; safety bar, grill slats and tailgate handle strip in black high-gloss, 15" light-alloy wheels and chrome-plated tailpipe trim.

## MINI COOPER S.

Better, faster, stronger: The 2.0l 4-cylinder petrol engine with 141 kW/192 hp and the 2.0l common-rail diesel engine\* with 125 kW/170 hp both pack a powerfully sporty punch. As emphasized by the air inlets in the bumper and bonnet and by the rear apron with diffusor insert, centreline twin exhaust tailpipes and model-specific rear spoiler.

\* Available until May 2019.

Information regarding fuel consumption and CO<sub>2</sub> emissions for all models, as required under EU law, can be found in the Technical Data section beginning on page 52.

# SELECT YOUR UPGRADE.

You have plenty of options for configuring your MINI model of choice: You can pick and choose from a wide range of optional extras and there are the 4 attractive lines Salt, Pepper, Chili and John Cooper Works Trim. The parts in each of these packages have been carefully selected to complement each other – making your decision that much easier.

Of course you can combine these lines with other extras and accessories of your choice, for example Connected Navigation Plus (page 44) or John Cooper Works accessories (page 46).

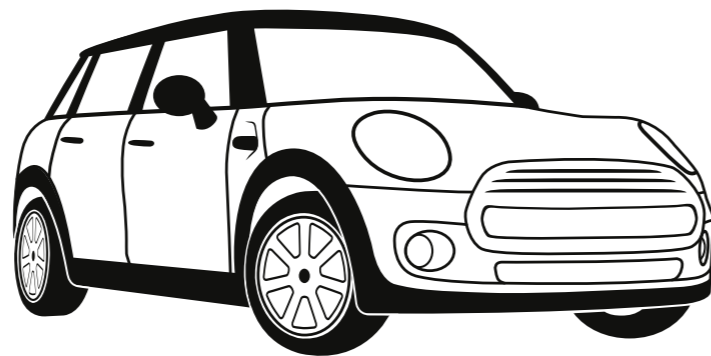

- |   |   |   |   |                         |
|---|---|---|---|-------------------------|
| ● | ○ | ○ | ○ | SALT.                   |
| ● | ● | ○ | ○ | PEPPER.                 |
| ● | ● | ● | ○ | CHILI.                  |
| ● | ● | ● | ● | JOHN COOPER WORKS TRIM. |

The Salt, Pepper, Chili and John Cooper Works Trim lines are graduated in scope and build upward step by step. They combine matching individual items in a single, harmonic entity. The fold-out page on the right shows details of the content you can add with each variant. For more information check online or contact your authorised MINI dealership.

[mini.com](http://mini.com)





## SALT.

The Salt equipment package adds a dash of extra comfort and technology to the mix: from velour floor mats through height adjustment for the passenger seat, lights and stowage packages, air conditioning (MINI One/Cooper), on-board computer and fog lights – a great basis for enjoying that touch of added comfort.

## PEPPER.

Salt extras and Pepper's added MINI Excitement package. It includes ambient lighting with cascade lighting, welcome, door-handle, door panel, footwell and centre stack lighting plus MINI logo projection from the driver's door mirror.

Also on board:

- + Automatic air conditioning
- + Rain sensor
- + Leather sports steering wheel
- + Mirror caps in vehicle colour (One/D)
- + 15" Heli Spoke (One/D) or 16" Loop Spoke (Cooper/D)

## CHILI.

On top of all the extras in Salt and Pepper, the Chili package brings even more sporting flair and innovative technology to bear. Features include:

- + Dynamic Cruise Control
- + MINI Driving Modes
- + Sports seats with Diamond Carbon Black cloth-leather combination
- + Headlights and fog lights with LED technology
- + 16" Victory Spoke (One/D)
- + 17" Tentacle Spoke (Cooper/D)
- + 17" Cosmos Spoke (Cooper S/SD)

## JOHN COOPER WORKS TRIM.

This package combines Salt, Pepper and Chili with selected exterior and interior elements from the John Cooper Works range. The result is a totally sporty look and feel with:

- + John Cooper Works leather sports steering wheel
- + John Cooper Works sports seats with integrated headrest and Double Stripe Carbon Black upholstery
- + Performance Control (One/Cooper)
- + Rear spoiler
- + John Cooper Works aerodynamics kit
- + Headliner in anthracite
- + Pedal assembly and footrest in stainless steel
- + John Cooper Works door sill cover strips and shift-lever knob
- + Sports suspension at no extra cost on request
- + 17" Track Spoke Black

# OUTSTANDING IN ANY COLOUR.



Standard colour Moonwalk Grey\*

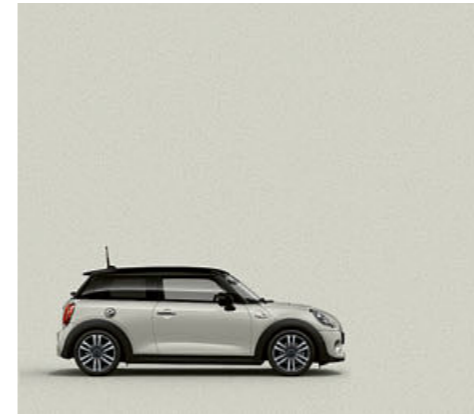

White Silver\*



Melting Silver\*



Thunder Grey\*\*/\*\*



Emerald Grey\*

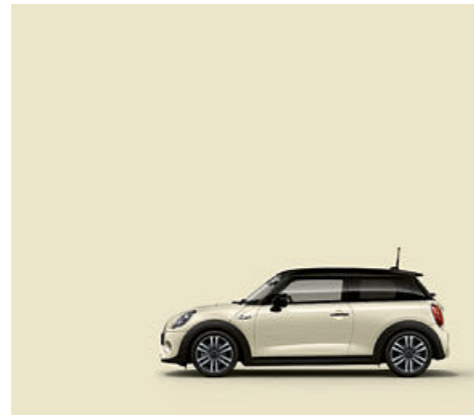

Pepper White

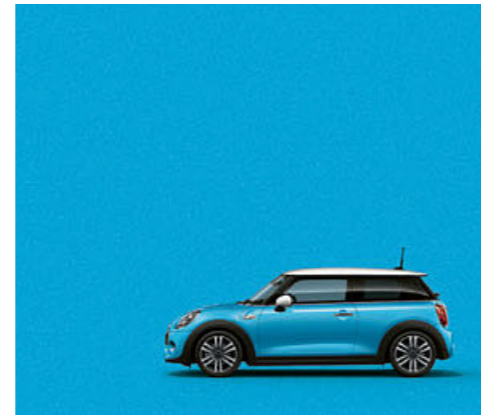

Electric Blue\*



Starlight Blue\*

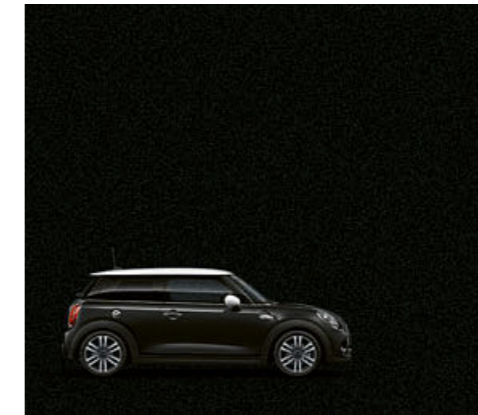

Midnight Black\*

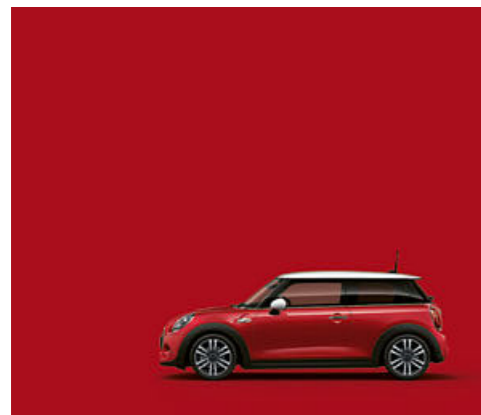

Chili Red

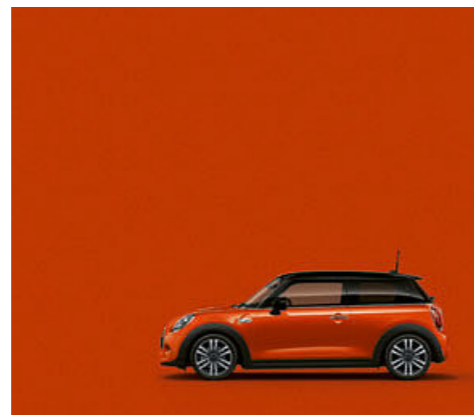

Solaris Orange\*

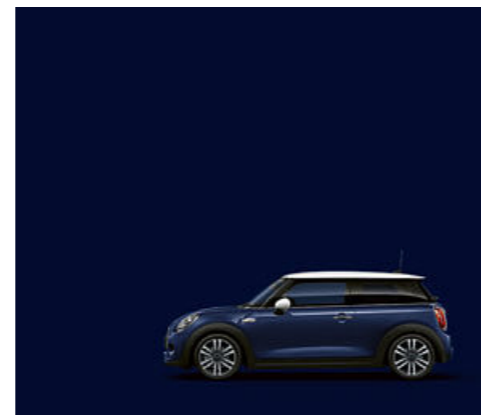

Exclusive finish: MINI Yours Lapisluxury Blue

\* Metallic.  
\*\* Available only for Cooper S/SD.

## Roof and exterior mirror caps.

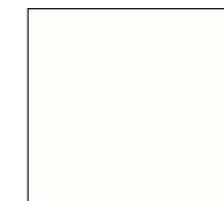

Aspen White

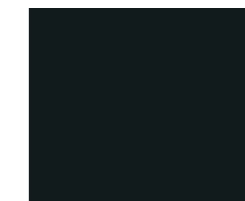

Jet Black

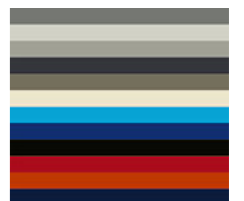

Body colour



# NICE WHEELS.

- 1 17" Rail Spoke 2-tone
- 2 18" MINI Yours Vanity Spoke 2-tone
- 3 18" John Cooper Works Cup Spoke 2-tone\*
- 4 18" Cone Spoke
- 5 18" Cone Spoke white
- 6 17" John Cooper Works Multi-Spoke 505 Jet Black matt\*\*
- 7 18" John Cooper Works Cross Spoke 506 2-tone (Jet Black, burnished)\*\*
- 8 17" John Cooper Works Track Spoke black\*
- 9 17" Roulette Spoke 2-tone
- 10 17" Cosmos Spoke
- 11 17" Cosmos Spoke black
- 12 17" Tentacle Spoke
- 13 17" Propeller Spoke 2-tone
- 14 16" Victory Spoke black
- 15 16" Loop Spoke
- 16 15" Heli Spoke

\* Available only with the John Cooper Works package or the John Cooper Works Trim line.  
 \*\* Available from [mini.com/accessories](http://mini.com/accessories)

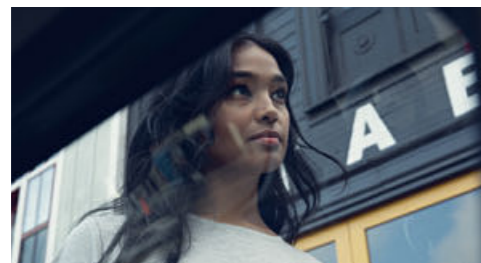

## YOUR INTERIOR, YOUR ROOM.

Design your MINI's interior to your taste. You have 4 different Colour Lines, 6 interior surfaces and other elements to choose from, and you can combine them with the seats you like best and with other design elements. Some of the details are on the next two-page spread.

The panorama view of the interior on the right shows leather trim in Chester Malt Brown\* with matching Colour Line Malt Brown and the MINI Yours Interior Style Piano Black illuminated interior surface with texture elements and decorative rings in Piano Black.

\* See page 32 for more details on leather trim.



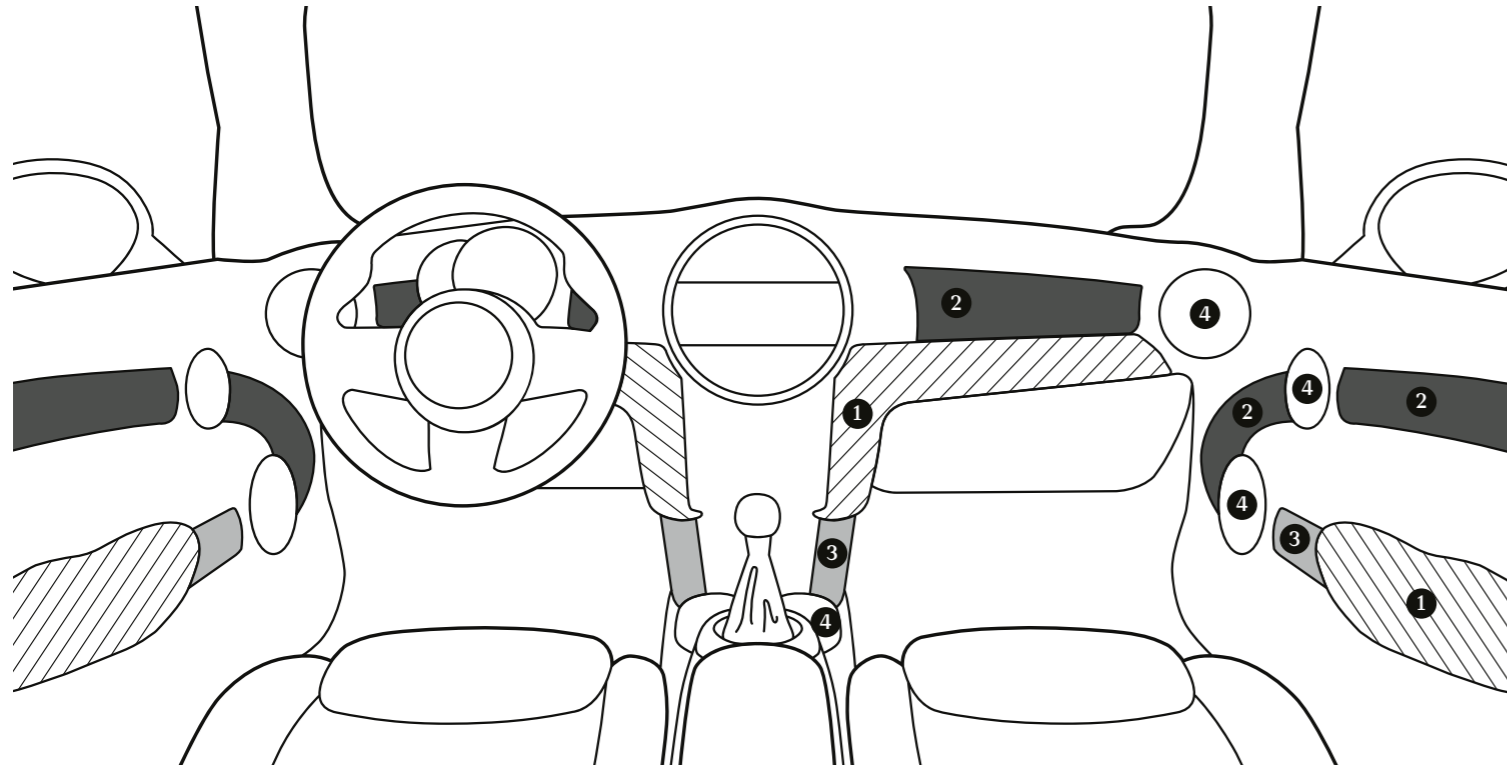

## INTERIOR ELEMENTS.

Broadly speaking, you have 4 design elements as building blocks for your individually designed interior: With the Colour Line (1) you define the colours of the door armrests and knee rolls. Your choice of interior surfaces (2) determines the material of door trim strips and cockpit trim strips and the corresponding structural elements (3). The MINI Yours Interior Style Fibre Alloy option includes LED piping with ambient lighting in the door trim strip. You have more design options to choose from with the colours of the decorative rings (4) round the speakers, door openers, outer air vents and gear lever.

[mini.com](http://mini.com)



**1 The 4 Colour Lines.**



Carbon Black



Malt Brown



Glowing Red



Satellite Grey

**2 The 6 interior surfaces.**



Piano Black\*



Dark Silver

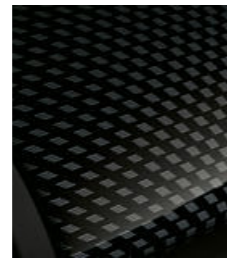

Black Chequered\*\*



Hazy Grey  
(no door trim strip)



MINI Yours  
Piano Black illuminated\*\*



MINI Yours Interior  
Style Fibre Alloy\*\*

**3 The 2 texture elements.**

The colour of the texture elements is Piano Black if optional interior surfaces are selected.  
In the MINI One and MINI Cooper, in combination with the standard equipment their colour is Hazy Grey.

**4 The 2 decorative rings.**



Piano Black



Chrome Line Interior

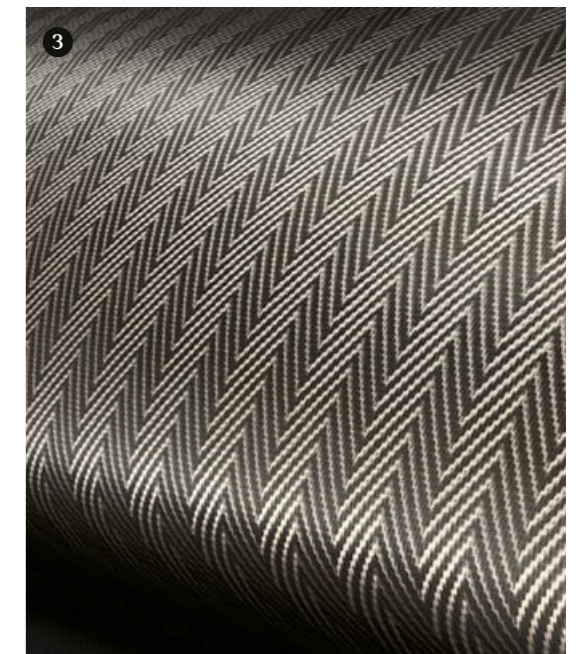
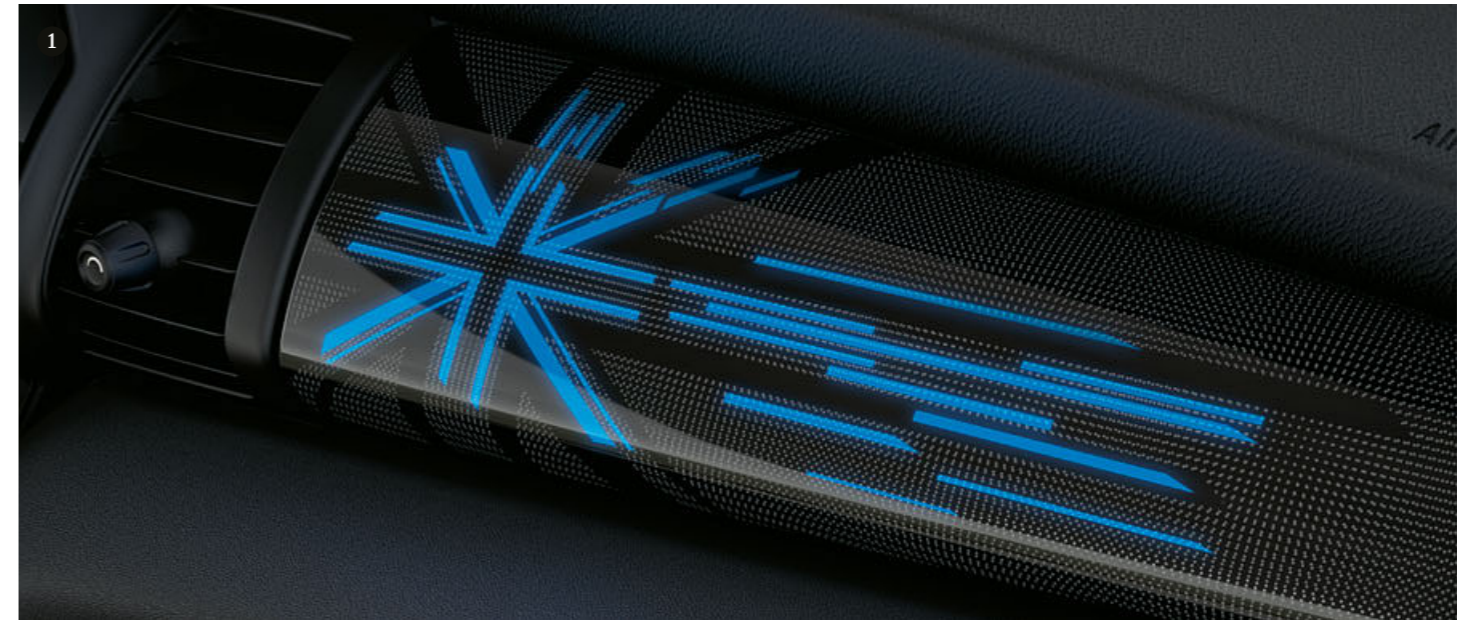

**1** Colour Line Carbon Black, MINI Yours Interior Style Piano Black illuminated cockpit trim strip with Union Jack, texture elements in Piano Black

**2** Colour Line Satellite Grey, door trim strip, texture elements and decorative rings in Piano Black

**3** MINI Yours Interior Style Fibre Alloy cockpit trim strip

\* Basis for MINI Yours Customised.  
\*\* With door trim strips in Piano Black.





# MINI YOURS: THE FINEST SELECTION.

Every MINI is special – but you can enhance the sensation with features from the MINI Yours design range. MINI Yours is the hallmark of maximum exclusiveness and individuality, because every extra you choose has its own story to tell.

You can see and feel it in many details: take the MINI Yours leather trim, the MINI Yours logo with Union Jack and sewing needle (1). The MINI Yours leather sports steering wheel (2) – finished in tumbled nappa leather and boasting contrasting-colour stitching – is supremely comfortable to the touch. The 18" MINI Yours Vanity Spoke 2-tone light-alloy wheels (3), partly burnished and exclusively finished in Spectre Grey paint, are just as striking as the MINI Yours Lapisluxury Blue exterior paintwork – a dark ultra-marine blue with spectacular depth (3).

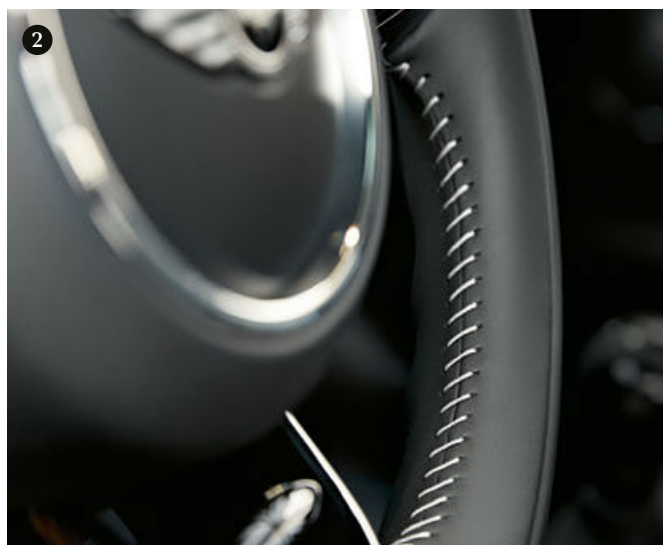

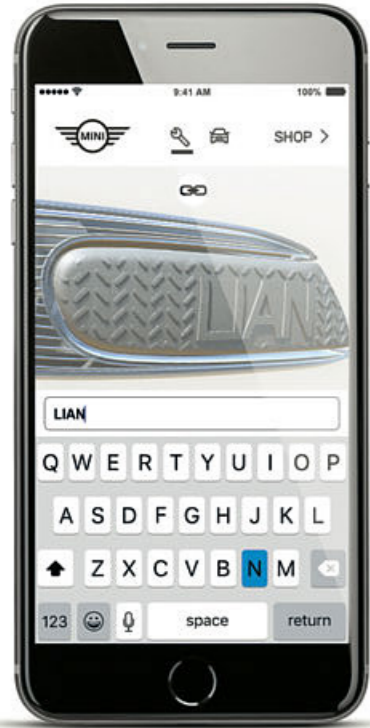

# MINI YOURS CUSTOMISED.

Would you like a car with signature details all of its own, matching your personal style one to one? Then explore the possibilities of MINI Yours Customised and go creative. Design as many as 4 special signature details as one-offs and make your MINI as unique as your fingerprint.

You can pick and choose your individualised MINI equipment in the MINI Yours Customised webshop on your smartphone, tablet or desktop PC. We use digital processes like 3D printing and laser technology to ensure outstanding quality and accuracy of fit.

Discover more at [yours-customised.mini](https://yours-customised.mini)

Availability may vary between countries.

## Here's how it works:

Use [yours-customised.mini](https://yours-customised.mini) to visit the webshop – Choose the product you want and create your very own design – Preview your design online in or on the car – Save your finished design and place your order – Install your signature parts yourself or have them installed by your authorised MINI dealer.

### 1 CUSTOM MINI SIDE SCUTTLES.

Design your very own side scuttles and show people what counts. Browse the wide range of options, choose the look you like best, add your personalised lettering. Available in set of 2, different designs for left and right sides are possible.

### 2 CUSTOM MINI DECORATIVE STRIP.

Have the motif you like best in view all the time: design your very own 3D-printed decorative strip for the passenger's side: Choose from different colours and patterns and pick out the icon you want. Then add your personalised lettering or a name. The Piano Black finish is the prerequisite because then the original is easily removed and your custom decorative strip is easily installed.

### 3 ILLUMINATED DOOR SILL COVER STRIPS.

Modern laser technology burns your message into your MINI's door sill cover strips: You have a choice of colour variants in black and brushed aluminium. For the driver's side and passenger's side you can order different patterns, from icons through to a replica of your own handwritten signature. Lighting by battery-powered LEDs.

### 4 CUSTOM MINI LED DOOR PROJECTORS.\*

Design the slide for your personalised door lighting and define the motif that will be projected on to the ground when the door is opened – from icons and patterns to a replica of your signature, or your initials. Different designs on left and right possible.

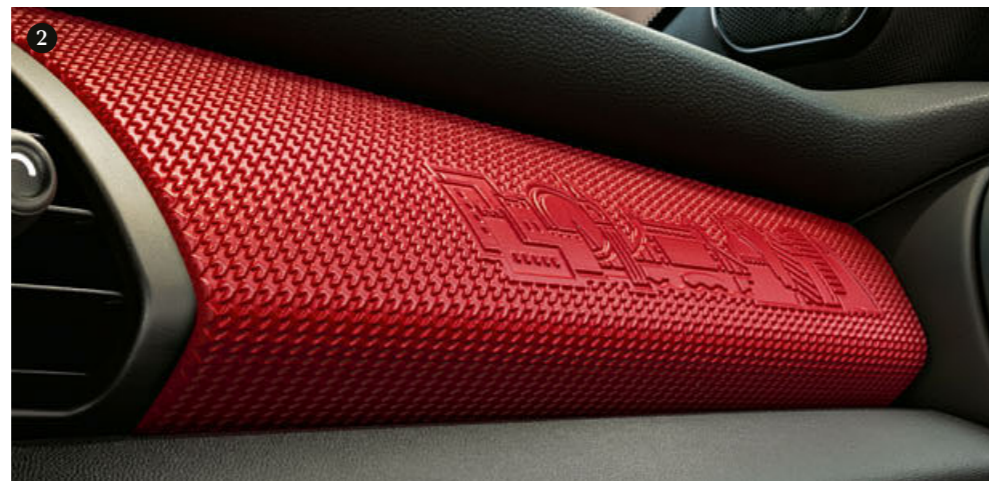

\*Available in combination with lights package.

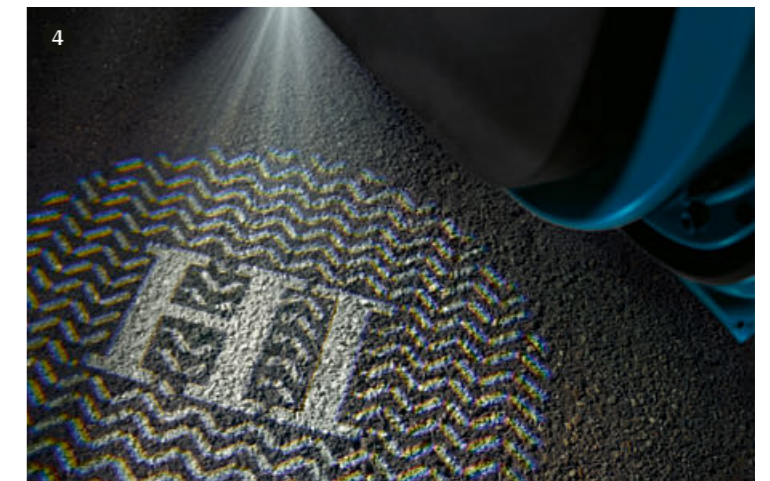

# PERFECT POSTURE FOR A PERFECT CURVE.



## MINI YOURS.

A job well done: From the perfect surface feel of the leather through the Union Jack tooled into the back of the head restraint to the eye-catching welts – the workmanship that goes into the making of the MINI Yours seats with seat surfaces in ultra-exclusive leather Lounge\* Carbon Black is something you'll appreciate every time you take your seat in the car.



**Sports seat**  
Leather Chester\*\*  
Malt Brown



**John Cooper Works sports seat**  
Dinamica/leather combination  
Carbon Black



**John Cooper Works sports seat**  
Dinamica/cloth combination  
Carbon Black



**Standard seat, One/Cooper**  
Cloth Firework  
Carbon Black



**Standard sports seat, Cooper S**  
Cloth Double Stripe  
Carbon Black



**Sports seat**  
Cloth/leatherette combination  
Black Pearl Carbon Black



**Sports seat**  
Cloth/leather combination  
Diamond Carbon Black



**Sports seat**  
Leather Cross Punch\*\*  
Carbon Black



**Sports seat**  
Leather Lounge\*  
Satellite Grey

No matter whether you prefer cloth, leather or a combination of both, whether you want outstanding comfort or sporty side support as you take twisting roads at speed – the seats in your MINI need to be ideal for you and your passengers, so you have a choice of 10 seat covers. Your local authorised MINI dealer has samples of all the materials so you can test their look and feel.

[mini.com](http://mini.com)

\* Leather for the seat surfaces, the backrests and the head restraints front and back.  
\*\* Leather for the seat surfaces and the head restraints front and back.

# MULTITASKING AT HAND.



All MINI steering wheels have multifunction buttons as standard so that you can control functions like the radio or the hands-free system while keeping your grip on the wheel. Extra exclusiveness: the MINI Yours version in nappa leather (1) and the John Cooper Works leather sports steering wheel (2) with red stitching.

- ❶ MINI Yours leather sports steering wheel
- ❷ John Cooper Works leather sports steering wheel
- ❸ Leather sports steering wheel (standard in the MINI Cooper S)
- ❹ 3-spoke standard steering wheel (standard in the MINI One/Cooper)



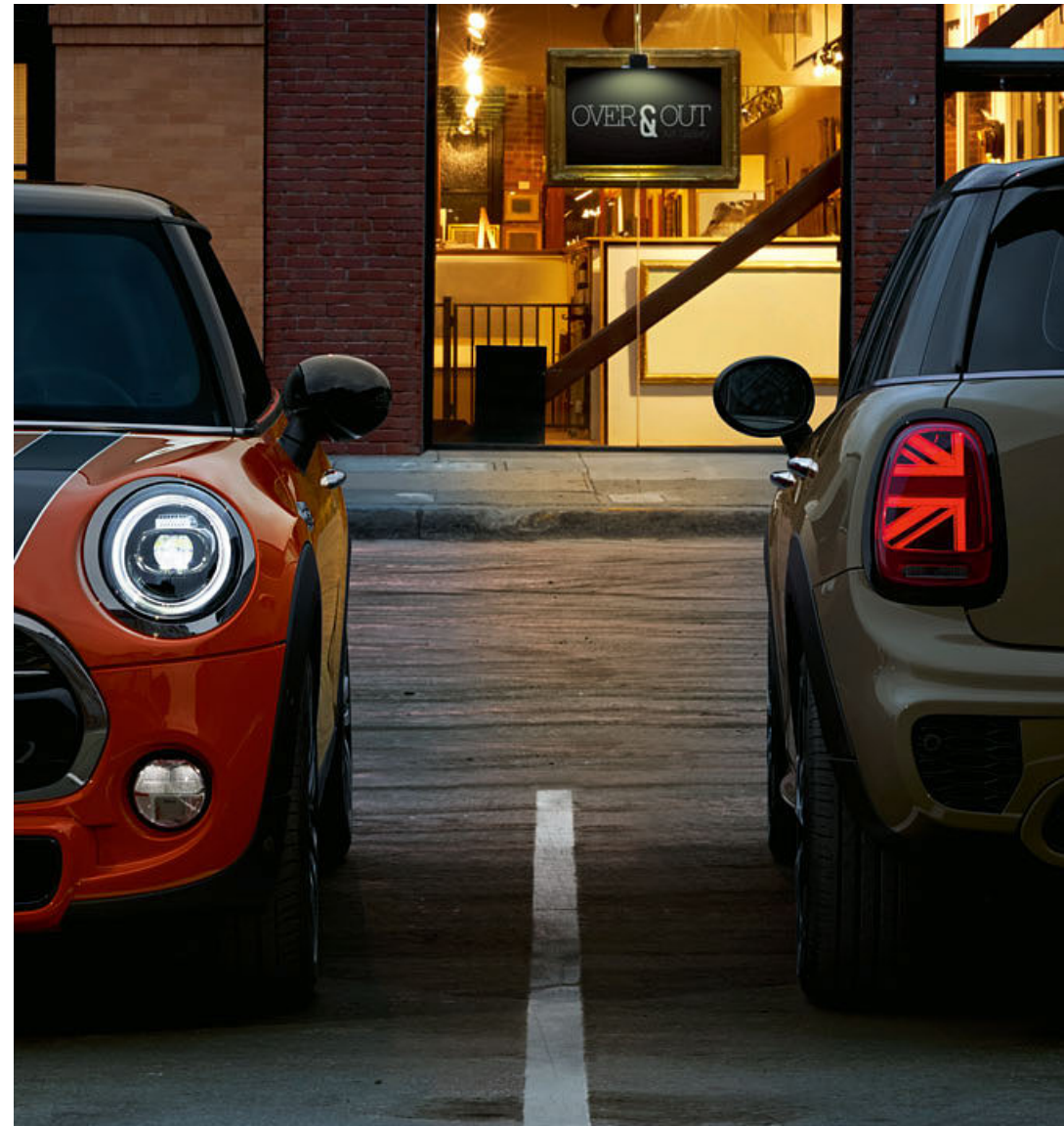

# GIVES LIGHT A BETTER LOOK.

Looking well ahead: In the dark, the optional LED light with matrix lighting functionality lets you see exactly what's what. The modern design adds to your car's unmistakable appearance – LED daytime driving lights and LED turn indicators are integrated elegantly into the outer light rings of the headlights. A very sporty touch is added by the Piano Black Exterior option with black bezels round headlights, radiator grille and the rear

lights – it is an option reserved exclusively for the MINI Cooper S/SD. LED light sources are long-lasting and this technology is standard for the rear lights of all 3-door and 5-door MINI models. The typically British Union Jack design shown here is available in combination with all optional LED headlights.

# SUPPORTIVE, PROTECTIVE, INNOVATIVE.

- 1 Now you'll never lose sight of the important things. The MINI head-up display shows you the data you need as you drive, and you don't have to take your eyes off the road ahead. Depending on the optional equipment installed, it notifies you of speed limits and no-overtaking zones, for example. It flashes up instructions issued by the navigation system and shows you the current cruise control setting.

The Driving Assistant can help prevent collisions with vehicles and pedestrians. The features include active cruise control to maintain the right distance back from the vehicle in front. At high speeds it makes stopping distances shorter. In urban traffic it can even initiate braking automatically.

If the worst happens and an accident occurs, the MINI intelligent emergency call system notifies the emergency services and reports location, direction of travel and accident severity. So help gets to the scene all the faster (no graphic).

- 2 The innovative 7-speed automatic double-clutch transmission with ergonomic electronic selector lever shifts without interruption of tractive force, enhances comfort and saves fuel.

The Parking Assistant helps you find a suitable parking space and makes parallel parking easy. The rear view camera transmits its images to the MINI Centre Instrument so you can see if it's OK to reverse (no graphic).

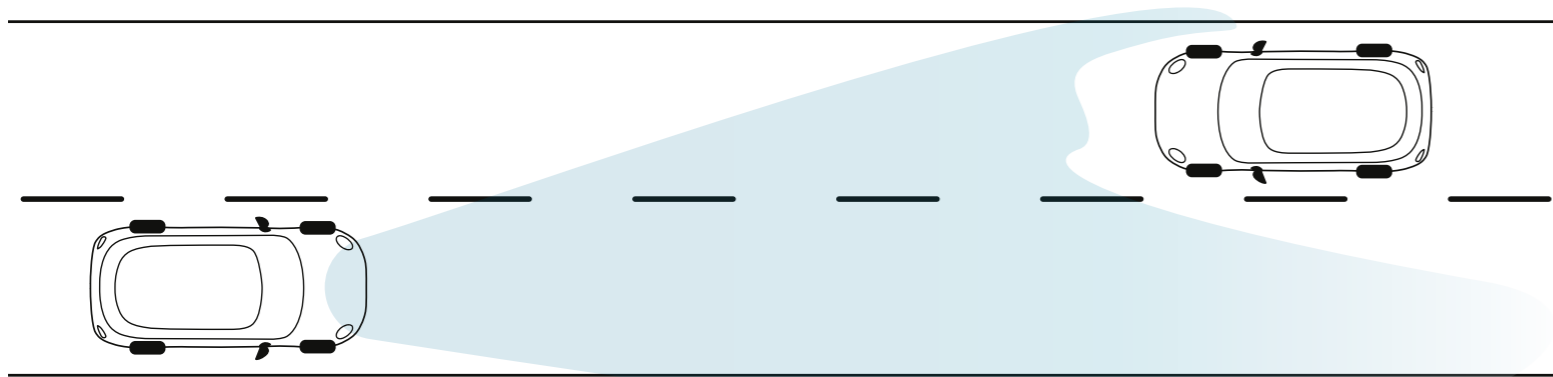

## MATRIX LIGHTING FUNCTIONALITY: ALWAYS AT THE READY.

You can order your MINI with all-LED adaptive headlights with integral cornering lights and daytime driving lights, plus high beams with camera-controlled matrix function. This camera-controlled technology detects oncoming vehicles and vehicles on the carriageway ahead and temporarily blanks out parts of the full-beam cone so that you don't have to switch to low beams (see the illustration above).





# MINI CONNECTED: WELCOME THE WORLD.

MINI Connected is the perfect link between your MINI and your digital life. MINI Connected seamlessly integrates your smartphone, various smartphone apps and the MINI Connected app into your MINI – which is equipped with its own SIM card. So you have new ways of interacting with the car, including for example smart voice control, remote services or your personal concierge. All this, plus smart navigation that learns frequently visited destinations, takes real-time traffic information into consideration and gets you from A to B even more effectively.

The MINI Connected app is a mobile extension of your car that keeps you in touch with your MINI and what's happening around you. Use the app whenever and wherever you want to call up information about your MINI – and because its linked to the scheduler on your smartphone your MINI will notify you in good time when you have appointments coming up. All MINI Connected functions are being refined all the time, so every trip will be more exciting, more relaxed and more enjoyable than ever before.

[mini.com/connected](http://mini.com/connected)

Access all the benefits of MINI Connected with the Connected Navigation Plus option. It comes with the MINI navigation system with 22.4 cm/8.8" touchscreen plus alternative operation via the MINI Touch Controller on the centre console, and wireless charging. So you have in-car wireless charging and your phone connects to the car's external antenna. Along with many other online functions for networked navigation, the package includes online speech processing, MINI Connected XL and the Apple CarPlay ready kit.

Shown opposite is a MINI 3-door.

# MAKE YOUR WAY WITH EASE.

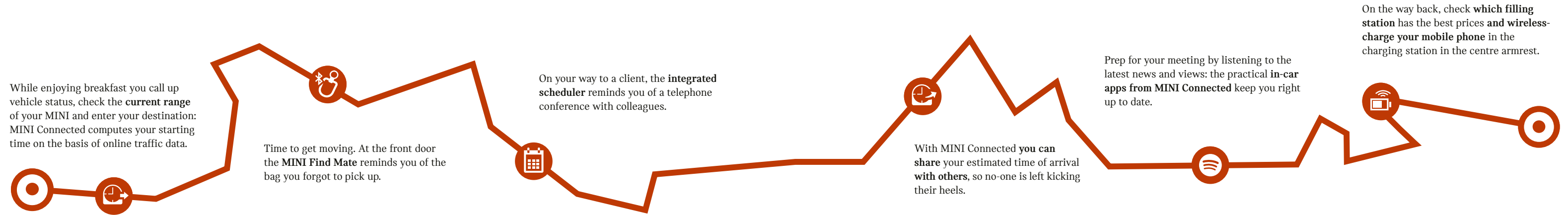

## SELECTED INTERACTIVE FUNCTIONS.



### REMOTE SERVICES AND VEHICLE STATUS.

Use your smartphone to unlock or lock your MINI, sound the horn and flash the high beams. The status display shows you where your MINI is, calculates the available range and, when you enter a destination, works out how long it will currently take you to drive there.



### CONNECTED DRIVE SERVICES AND MINI ONLINE FUNCTIONS.

Use the MINI Connected Service apps to check fuel prices at filling stations, pick up messages and receive weather forecasts for your route and destination.



### MINI FIND MATE.

Keep important items safe with a MINI Find Mate tag. As soon as your smartphone is too far away, the MINI Connected app issues a warning and shows you the last known location of the tagged item.



### APPLE CARPLAY READY KIT.

The Apple CarPlay ready kit makes it easy for you to interconnect your iPhone with the display, the controls and the speakers of your MINI. Then you have many apps that you use on your iPhone available on your trip.



### MINI CONCIERGE SERVICE.

You can access the MINI Concierge Service around the clock through your MINI Connected menu. The service will find the answers to your questions, look up addresses and transmit them to the car's satnav, even book hotel accommodation for you.



### SPOTIFY.

A huge number of pre-configured apps for MINI Connected allow you to listen to your favourite music while you're on the move. Use Spotify to discover the latest releases, for example, and manage your personal playlists.

## SELECTED FUNCTIONS FOR SMART NAVIGATION.



### RTTI

### REAL TIME TRAFFIC INFORMATION.

RTTI reports the momentary traffic situation and sends the data to the satnav. The system estimates the delay and suggests alternative routes.



### ONLINE SEARCH.

Going shopping or eating out? Once you've found somewhere suitable using Online Search, you can send the address to the navigation system, and the phone number to your smartphone, so you can book a table.



### FREQUENTLY VISITED PLACES AND SUGGESTED DEPARTURE TIMES.

MINI Connected lists visited, learned or saved destinations and checks the current journey time online. When it's time to leave for a planned destination, MINI Connected notifies you on your smartphone or Apple Watch.



### SEND DESTINATION FROM SMARTPHONE TO NAVIGATION SYSTEM.

As long as your smartphone is paired to your vehicle, destinations (learned, saved or imported from your calendar) are automatically saved to the navigation system. Route guidance starts automatically (depending on equipment fitted).



### CALENDAR INTEGRATION.

MINI Connected can import all destinations from your smartphone calendar. Without any action on your part, it reminds you when it is time to get going and puts your destinations directly into the navigation system.



### WIRELESS CHARGING.

Wireless charging automatically tops up the battery as soon as you lay your mobile phone in the charging station in the centre armrest. In this position it is connected directly to the car's external antenna for better voice quality. Most devices support both functions; check with your authorised MINI dealer for compatibility details.



# THE MINI CONNECTED APP.

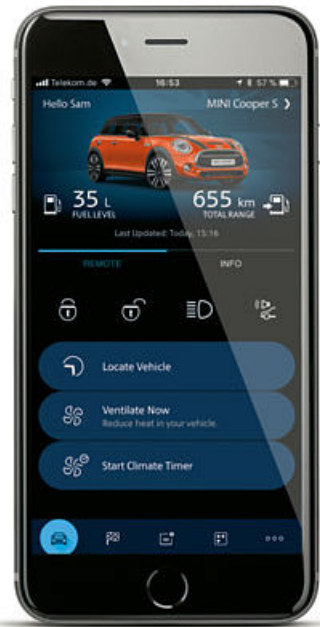

The MINI Connected app lets you unlock and lock your MINI remotely with your smartphone, call up its location and check vehicle status information. Before you even leave home you can enter your destination and send it directly to the car's satnav. The app reminds you when it is time to leave – on the basis of up-to-the-minute traffic information. With these and many other functions, the smartphone app significantly widens the versatility of your MINI.

The MINI Connected in-car apps will keep you up to date as you drive, giving you access to the latest news, weather forecasts and traffic reports or finding the filling station with the lowest prices in the vicinity.



## NATURAL LANGUAGE RECOGNITION. REAL TIME TRAFFIC INFORMATION.

Natural language recognition with offboard speech processing makes it far easier to use voice commands in your MINI. Your car now recognises sentences in different variations, understands many abbreviations and even pauses. That makes it easier for you to control your MINI by voice commands. Finding your destination of choice or changing settings by voice has become a whole lot easier.

With RTTI – Real Time Traffic Information – MINI Connected keeps the optional navigation system supplied with the latest traffic data. If something unexpected happens on the route ahead the system estimates the delay and suggests the best alternative routes.





## MINI CONCIERGE SERVICE.

The MINI Concierge Service is available to use around the clock to make sure that everything is exactly as it should be. Call up your PA easily and directly via your MINI's touchscreen. The fast and secure telephone connection is set up by the in-car SIM card – even when you're in a foreign country and without additional fees.

The MINI Concierge Service looks up domestic and foreign addresses and puts them straight into the car's satnav system. Use it to find the nearest pharmacy, call up flight schedules, find out what's showing in which cinema, even to book hotel accommodation, and save yourself time and effort when you're away from home.



## APPLE CARPLAY.

With Connected Navigation and higher options, the Apple CarPlay ready kit is on board. CarPlay interconnects your iPhone with the display and the speakers of your MINI. So you can control the main functions of your iPhone using your MINI's controls or Siri voice control. With CarPlay you have many apps that you use on your iPhone at your disposal in-car. You can conduct phone calls, listen to music, call up route descriptions, have incoming text messages read out, dictate and send your own text messages, and much more.

# YOUR MEANS OF COMMUNICATION.



## 1 STANDARD RADIO.

The standard radio has a 16.4 cm/6.5" screen, Bluetooth hands-free and audio streaming plus USB audio interface.



## 2 CONNECTED MEDIA.

Better connected to all services for networked visual radio: the MINI Visual Boost radio with 16.4 cm/6.5" screen, operation by touchscreen or MINI Controller, MINI Connected interface for operation by smartphone with the MINI Connected app.



## 3 CONNECTED NAVIGATION.

Appropriately networked to all data for better navigation: the high-end navigation functionality with 16.4 cm/6.5" screen with real time traffic information, automatic online map updates, extended MINI Connected services and Apple CarPlay.

## 4 CONNECTED NAVIGATION PLUS.

Even more scope for maximum possibilities: the 22.4 cm/8.8" screen with splitscreen function, MINI Connected XL, wireless charging for mobile phone, second USB port and ergonomic MINI Touch Controller.

## MINI FIND MATE.

Forget forgetting: Connected Navigation Plus includes a MINI Find Mate, a small Bluetooth tag for you to attach to important items. As soon as you go a certain distance away from the tagged item, the MINI Connected app sends a signal to your smartphone and if you want it will show you the way back to the item's last known GPS location. The MINI Connected app can administrate up to 6 MINI Find Mates. Get the Find Mates from MINI Lifestyle.





## JOHN COOPER WORKS ACCESSORIES. SHARPEN THE LOOK.



Our dynamically styled JCW accessories create even more MINI-typical motorsport character. The 18" JCW Cross Spoke 506 light-alloy wheels in 2-tone (Jet Black, burnished) (2) are an impressive feature. Forged aluminium, they are partly diamond polished, back-turned and weight-optimised.

Detail-perfect visuals are added by the striking JCW mirror caps (1) and the sporty JCW air inlet bezel (3) in ultra-light carbon.

John Cooper Works accessories  
[mini.com/accessories](http://mini.com/accessories)



# DRIVING THE FUTURE OF MOBILITY.

We have never been so connected – and life has never been so fast-paced. So we need vehicles that can keep up with our lifestyles. And this is why a MINI excels in many different ways. A MINI is all about being yourself, enjoying your journey and turning heads along the way. But it's also about having the right mindset. This means loving what we do. And recognising the value in certain things, whether it's because they mean something, because they're important or because they look good. Since 1959, we have strived to retain what sets MINI apart while creating something new. We want to inspire others to help us develop better ways of going places, which we can appreciate today – and in the future.

#### Recycling.

At every stage, from design to disassembly, recycling is central to the MINI philosophy. For example, all the materials used in each vehicle's manufacture are selected because they can be used in the most sustainable and environmentally friendly way possible. That way, every MINI can be efficiently and ecologically recycled when its driving days are finally done. We have been working on this approach since 1994 at the BMW Group Recycling and Disassembly Centre in Munich, Germany, the only facility of its kind. Your MINI dealer will be pleased to advise you on the disposal of your old vehicle, or you can visit [mini.com/recycling](https://www.mini.com/recycling)



## MINI SERVICE.

**For values that we pass on to others. MINI Service.**

MINI Service partners share your passion. Entrust your MINI to our MINI Service partners. In electronics, mechanics, body work, paintwork and touch-up repairs, they have the skills to keep it in tip-top order. They use genuine MINI parts, to keep you safe and sound.

**Just like in the good new times. MINI warranty extension.**

Extend that new-car feeling. When you take out an extended warranty your new MINI is well covered even after the statutory warranty period expires. For up to 5 years. Worldwide! See for yourself – at [mini.com](http://mini.com)

**Everything taken care of. Passion is what's left. MINI Service Inclusive.**

Now you only have to think about it once and never again. Take out MINI Service Inclusive coverage when you buy your new MINI. After that, for up to 6 years all the included servicing and maintenance work is taken care of by a single payment. No-worries driving, guaranteed! See for yourself – at [mini.com](http://mini.com)

**Your MINI calls in when it needs something. MINI Teleservices.**

Always on the move, you can't think of everything, so let your MINI do it for you. With Condition Based Service you automatically get a reminder in the MINI Centre Instrument when the next service appointment is due. With MINI Teleservices the car automatically sends the essential vehicle data for the next condition-based service directly to MINI. Your MINI Service dealership of choice gets the data and contacts you to arrange a date and time for a visit to the workshop – if necessary. The only prerequisite: you must have the "MINI Connected" or "intelligent emergency call" option and a vehicle registered in the MINI Connected app or, as of May 2018, a vehicle registered in the MINI Connected online portal (subject to availability). If you decide you don't need MINI Teleservices you can deactivate the setting whenever you want. More at [mini.com](http://mini.com)

**We keep your MINI mobile. MINI breakdown and accident assistance.**

24 hours a day – 365 days a year: The MINI breakdown and accident assistance service is always there in case you need it. We have an extensive country-specific mobility offering for breakdown assistance. We offer insurance coverage for accident and theft. Specially trained MINI technicians provide solutions by phone or in the field. Round the clock and round the world. Find out more – at [mini.com](http://mini.com)



## MINI FINANCIAL SERVICES.

**The key to the car of your dreams.**

MINI Financial Services\* represents the quickest way to the car of your dreams. With MINI Leasing, you pay to use the vehicle and not a penny more. MORE MINI packages provide a host of attractive extras, such as suitable insurance\*\*, a tailored service deal or even a combination of both.

If you want to own a MINI but stay flexible with your financing, you'll find a favourable deal with MINI Finance. And for total peace of mind, check out MINI Car Insurance.\*\*

Find out more about MINI Financial Services online at [mini.com](http://mini.com) or visit your local MINI dealership.\*\*\*

\* MINI Financial Services is a trade name of BMW Bank GmbH, Heidemannstr. 164, 80939 Munich, Germany.  
\*\* Contractual partner and risk carrier is Allianz Versicherungs-AG.  
\*\*\* Vehicle also includes a service package. See service package agreement for details.

### Warranty.

Every MINI is supplied with a 2-year dealer warranty against manufacturing defects. The MINI dealership where the purchase was made is responsible for honouring the warranty. Repair work can be carried out at any authorised MINI dealer, MINI Service Authorised Workshop or any other service centre authorised by MINI. Defects arising in the first 6 months after purchase are deemed by law to have existed at the time of purchase and the dealer has the onus of proving that the vehicle is not defective due to a manufacturing defect. Every MINI also comes with a 12-year anticorrosion warranty, which covers the vehicle against rusting of the body panels. The painted surfaces of the car are covered by a 3-year warranty. This warranty does not cover damage to the vehicle body or under-body caused by stone impacts, scratches or dents, accident damage or other damage caused by environmental factors. Failure to comply with the service schedule provided by the manufacturer may invalidate this warranty.

## TECHNICAL DATA FOR THE MINI 3-DOOR.

| Engine <sup>1,2</sup>                       |               | One First           | One                  | One D             | Cooper                | Cooper D             | Cooper S              | Cooper SD        |
|---|---------------|---------------------|----------------------|-------------------|-----------------------|----------------------|-----------------------|------------------|
| Cylinders/configuration/valves per cylinder |               | 3/in-line/4         | 3/in-line/4          | 3/in-line/4       | 3/in-line/4           | 3/in-line/4          | 4/in-line/4           | 4/in-line/4      |
| Displacement                                | cc            | 1499                | 1499                 | 1496              | 1499                  | 1496                 | 1998                  | 1995             |
| Nominal power/rated speed                   | kW/hp/<br>rpm | 55/75/<br>3500-6500 | 75/102/<br>3900-6500 | 70/95/<br>4000    | 100/136/<br>4500-6500 | 85/116/<br>4000      | 141/192/<br>5000-6000 | 125/170/<br>4000 |
| Max. torque/revs                            | Nm/rpm        | 160/1250-3000       | 190/1380-3600        | 220/1500-2500     | 220/1480-4200         | 270/1750-2250        | 280/1350-4600         | 360/1500-2750    |
| Compression ratio/fuel                      | -/l           | 11/91-98 RON        | 11/91-98 RON         | 16.5/diesel       | 11/91-98 RON          | 16.5/diesel          | 11/91-98 RON          | 16.5/diesel      |
| <b>Performance<sup>1</sup></b>              |               |                     |                      |                   |                       |                      |                       |                  |
| Max. speed                                  | km/h          | 173                 | 193 [193]            | 190               | 210 [210]             | 205 [204]            | 235 [235]             | [225]            |
| Acceleration 0-100 km/h                     | s             | 13                  | 10.3 [10.3]          | 11.2              | 8 [8]                 | 9.2 [9.3]            | 6.8 [6.7]             | [7.2]            |
| Acceleration 80-120 km/h (5th gear)         | s             | 15.8                | 12.4                 | 12.0              | 9.9 [-]               | 9.1 [-]              | 6.6 [-]               | [-]              |
| <b>Consumption<sup>1,2</sup></b>            |               |                     |                      |                   |                       |                      |                       |                  |
| Combined                                    | l/100 km      | 6.4-5.9             | 6.4-5.9<br>[6.6-6.0] | 4.6-4.2           | 6.4-5.9<br>[6.6-6.0]  | 4.7-4.2<br>[4.8-4.5] | 7.3-6.8<br>[7.2-6.5]  | [5.2-4.9]        |
| CO <sub>2</sub> emissions, combined         | g/km          | 145-133             | 145-133<br>[149-137] | 120-109           | 145-133<br>[149-137]  | 124-111<br>[127-117] | 165-155<br>[162-148]  | [137-128]        |
| Exhaust emissions standard (type-certified) |               | EU6d-temp           | EU6d-temp            | EU6d-temp         | EU6d-temp             | EU6d-temp            | EU6d-temp             | EU6d-temp        |
| Fuel tank capacity                          | l             | 40                  | 40                   | 44                | 40                    | 44                   | 44                    | 44               |
| <b>Weight/luggage capacity<sup>1</sup></b>  |               |                     |                      |                   |                       |                      |                       |                  |
| Unladen weight. (EU) <sup>3</sup>           | kg            | 1215                | 1215 [1245]          | 1225              | 1210 [1235]           | 1240 [1260]          | 1275 [1295]           | [1315]           |
| Max. permitted weight                       | kg            | 1565                | 1570 [1600]          | 1615              | 1565 [1595]           | 1635 [1650]          | 1640 [1635]           | [1700]           |
| Max. permitted load                         | kg            | 425                 | 430 [430]            | 465               | 430 [435]             | 470 [465]            | 440 [415]             | [460]            |
| Max. permitted axle load, front/rear        | kg            | 870/760             | 870/760<br>[900/760] | 910/765           | 870/755<br>[900/755]  | 930/755<br>[945/755] | 920/765<br>[935/765]  | [975/765]        |
| Luggage capacity                            | l             | 211-731             | 211-731              | 211-731           | 211-731               | 211-731              | 211-731               | 211-731          |
| <b>Wheels</b>                               |               |                     |                      |                   |                       |                      |                       |                  |
| Tyre dimensions, front/rear                 |               | 175/65 R15 88H XL   | 175/65 R15 88H XL    | 175/65 R15 88H XL | 175/65 R15 88H XL     | 175/65 R15 88H XL    | 195/55 R16 87W        | 195/55 R16 87W   |
| Wheel dimensions, front/rear                |               | 5.5 J x 15          | 5.5 J x 15           | 5.5 J x 15        | 5.5 J x 15            | 5.5 J x 15           | 6.5 J x 16            | 6.5 J x 16       |
| Material                                    |               | steel               | steel                | steel             | light alloy           | light alloy          | light alloy           | light alloy      |

<sup>1</sup> All figures relate to vehicles with the standard 6-speed manual transmission. Values in [ ] relate to vehicles with 7-speed/8-speed Steptronic transmission.

<sup>2</sup> The values shown for fuel consumption, CO<sub>2</sub> emissions and energy consumption are calculated in accordance with the measurement method prescribed in the European Regulation (EC) 715/2007 in the version applicable at the time of approval. The figures refer to a vehicle with basic configuration in Germany and the range shown considers optional equipment and the different size of wheels and tyres available on the selected model and may vary during the configuration. The values are already based on the new WLTP test cycle and have been translated back into NEDC-equivalent values for the purpose of comparison. [For these models, different values to those shown here apply when calculating taxes and other vehicle-related duties that (also) focus on the CO<sub>2</sub> emissions.]

<sup>3</sup> Assuming car is fuelled to 90% of tank capacity, and allowing 68 kg for the driver and 7 kg for luggage. The unladen weight quoted is for standard-specification vehicles. Optional equipment will increase this figure.

## MINI 3-DOOR DIMENSIONS.

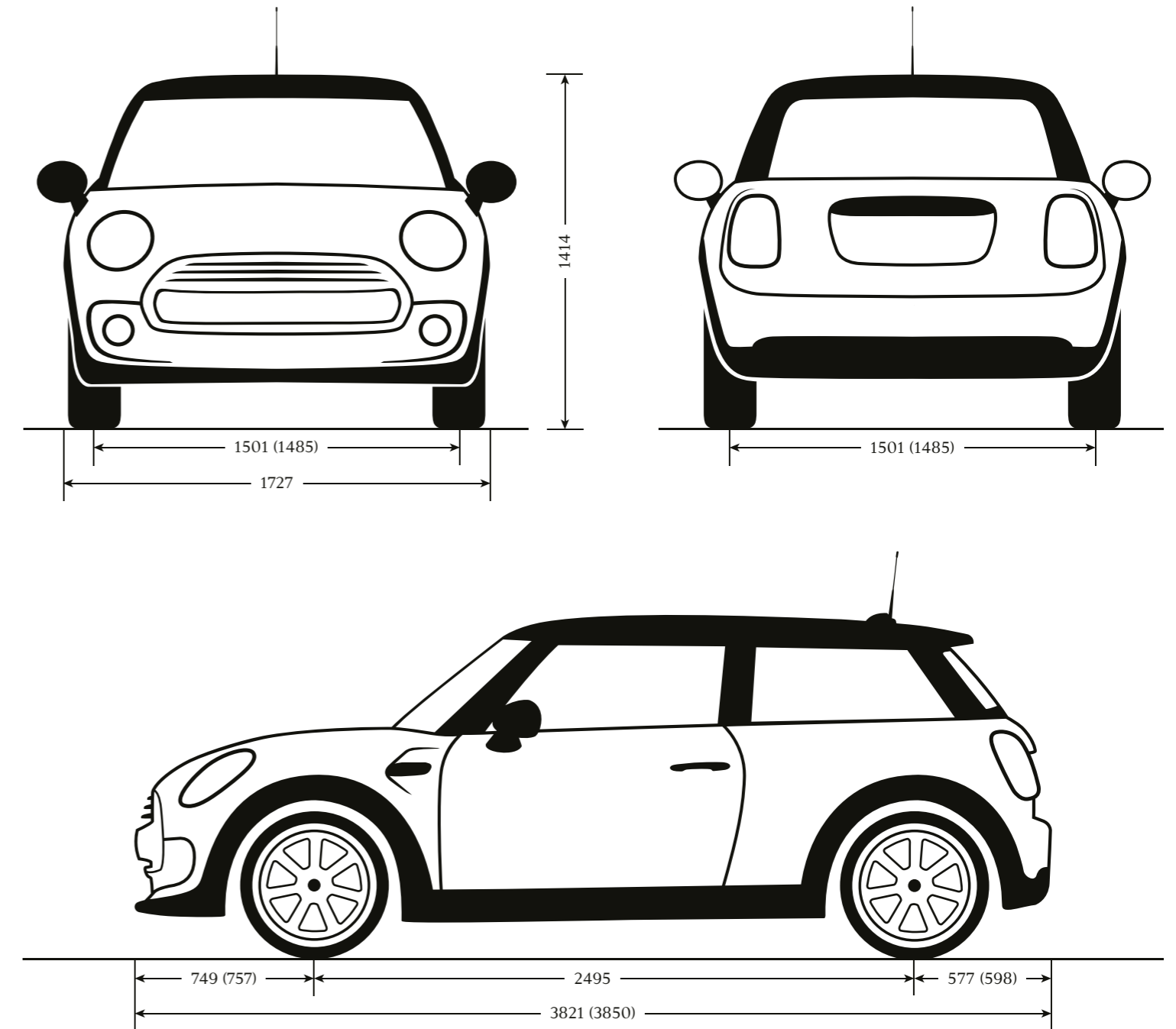

All figures are in millimetres (mm).  
Cooper S values in brackets.

## TECHNICAL DATA FOR THE MINI 5-DOOR.

| Engine <sup>1,2</sup>                       |               | One First           | One                  | One D             | Cooper                | Cooper D             | Cooper S              | Cooper SD        |
|---|---------------|---------------------|----------------------|-------------------|-----------------------|----------------------|-----------------------|------------------|
| Cylinders/configuration/valves per cylinder |               | 3/in-line/4         | 3/in-line/4          | 3/in-line/4       | 3/in-line/4           | 3/in-line/4          | 4/in-line/4           | 4/in-line/4      |
| Displacement                                | cc            | 1499                | 1499                 | 1496              | 1499                  | 1496                 | 1998                  | 1995             |
| Nominal power/rated speed                   | kW/hp/<br>rpm | 55/75/<br>3500-6500 | 75/102/<br>3900-6500 | 70/95/<br>4000    | 100/136/<br>4500-6500 | 85/116/<br>4000      | 141/192/<br>5000-6000 | 125/170/<br>4000 |
| Max. torque/revs                            | Nm/rpm        | 160/1250-3000       | 190/1380-3600        | 220/1500-2500     | 220/1480-4200         | 270/1750-2250        | 280/1350-4600         | 360/1500-2750    |
| Compression ratio/fuel                      | -/l           | 11/91-98 RON        | 11/91-98 RON         | 16.5/diesel       | 11/91-98 RON          | 16.5/diesel          | 11/91-98 RON          | 16.5/diesel      |
| <b>Performance<sup>1</sup></b>              |               |                     |                      |                   |                       |                      |                       |                  |
| Max. speed                                  | km/h          | 172                 | 192 [192]            | 187               | 207 [207]             | 203 [202]            | 235 [235]             | [223]            |
| Acceleration 0-100 km/h                     | s             | 13.4                | 10.6 [10.6]          | 11.6              | 8.3 [8.3]             | 9.4 [9.6]            | 6.9 [6.8]             | [7.3]            |
| Acceleration 80-120 km/h (5th gear)         | s             | 16.6                | 13.2 [-]             | 12.5              | 10.4 [-]              | 9.4 [-]              | 6.8 [-]               | [-]              |
| <b>Consumption<sup>1,2</sup></b>            |               |                     |                      |                   |                       |                      |                       |                  |
| Combined                                    | l/100 km      | 6.5-6.0             | 6.5-6.0<br>[6.7-6.1] | 4.7-4.3           | 6.5-6.0<br>[6.7-6.1]  | 4.8-4.3<br>[4.9-4.5] | 7.4-6.9<br>[7.3-6.6]  | [5.3-5.0]        |
| CO <sub>2</sub> emissions, combined         | g/km          | 147-136             | 147-135<br>[152-139] | 123-111           | 148-135<br>[151-139]  | 126-114<br>[129-119] | 168-157<br>[165-150]  | [139-130]        |
| Exhaust emissions standard (type-certified) |               | EU6d-temp           | EU6d-temp            | EU6d-temp         | EU6d-temp             | EU6d-temp            | EU6d-temp             | EU6d-temp        |
| Fuel tank capacity                          | l             | 40                  | 40                   | 44                | 40                    | 44                   | 44                    | 44               |
| <b>Weight/luggage capacity<sup>1</sup></b>  |               |                     |                      |                   |                       |                      |                       |                  |
| Unladen weight. (EU) <sup>3</sup>           | kg            | 1270                | 1275 [1300]          | 1280              | 1265 [1295]           | 1280 [1305]          | 1330 [1345]           | [1370]           |
| Max. permitted weight                       | kg            | 1680                | 1680 [1705]          | 1735              | 1685 [1710]           | 1740 [1755]          | 1750 [1770]           | [1770]           |
| Max. permitted load                         | kg            | 485                 | 480 [480]            | 530               | 495 [490]             | 535 [525]            | 495 [500]             | [475]            |
| Max. permitted axle load, front/rear        | kg            | 900/850             | 900/850<br>[925/850] | 940/855           | 910/845<br>[940/845]  | 950/850<br>[970/850] | 950/860<br>[970/860]  | [1005/860]       |
| Luggage capacity                            | l             | 278-941             | 278-941              | 278-941           | 278-941               | 278-941              | 278-941               | 278-941          |
| <b>Wheels</b>                               |               |                     |                      |                   |                       |                      |                       |                  |
| Tyre dimensions, front/rear                 |               | 175/65 R15 88H XL   | 175/65 R15 88H XL    | 175/65 R15 88H XL | 175/65 R15 88H XL     | 175/65 R15 88H XL    | 195/55 R16 87W        | 195/55 R16 87W   |
| Wheel dimensions, front/rear                |               | 5.5 J x 15          | 5.5 J x 15           | 5.5 J x 15        | 5.5 J x 15            | 5.5 J x 15           | 6.5 J x 16            | 6.5 J x 16       |
| Material                                    |               | steel               | steel                | steel             | light alloy           | light alloy          | light alloy           | light alloy      |

<sup>1</sup> All figures relate to vehicles with the standard 6-speed manual transmission. Values in [ ] relate to vehicles with 7-speed/8-speed Steptronic transmission.

<sup>2</sup> The values shown for fuel consumption, CO<sub>2</sub> emissions and energy consumption are calculated in accordance with the measurement method prescribed in the European Regulation (EC) 715/2007 in the version applicable at the time of approval. The figures refer to a vehicle with basic configuration in Germany and the range shown considers optional equipment and the different size of wheels and tyres available on the selected model and may vary during the configuration. The values are already based on the new WLTP test cycle and have been translated back into NEDC-equivalent values for the purpose of comparison. [For these models, different values to those shown here apply when calculating taxes and other vehicle-related duties that (also) focus on the CO<sub>2</sub> emissions.]

<sup>3</sup> Assuming car is fuelled to 90% of tank capacity, and allowing 68 kg for the driver and 7 kg for luggage. The unladen weight quoted is for standard-specification vehicles. Optional equipment will increase this figure.

## MINI 5-DOOR DIMENSIONS.

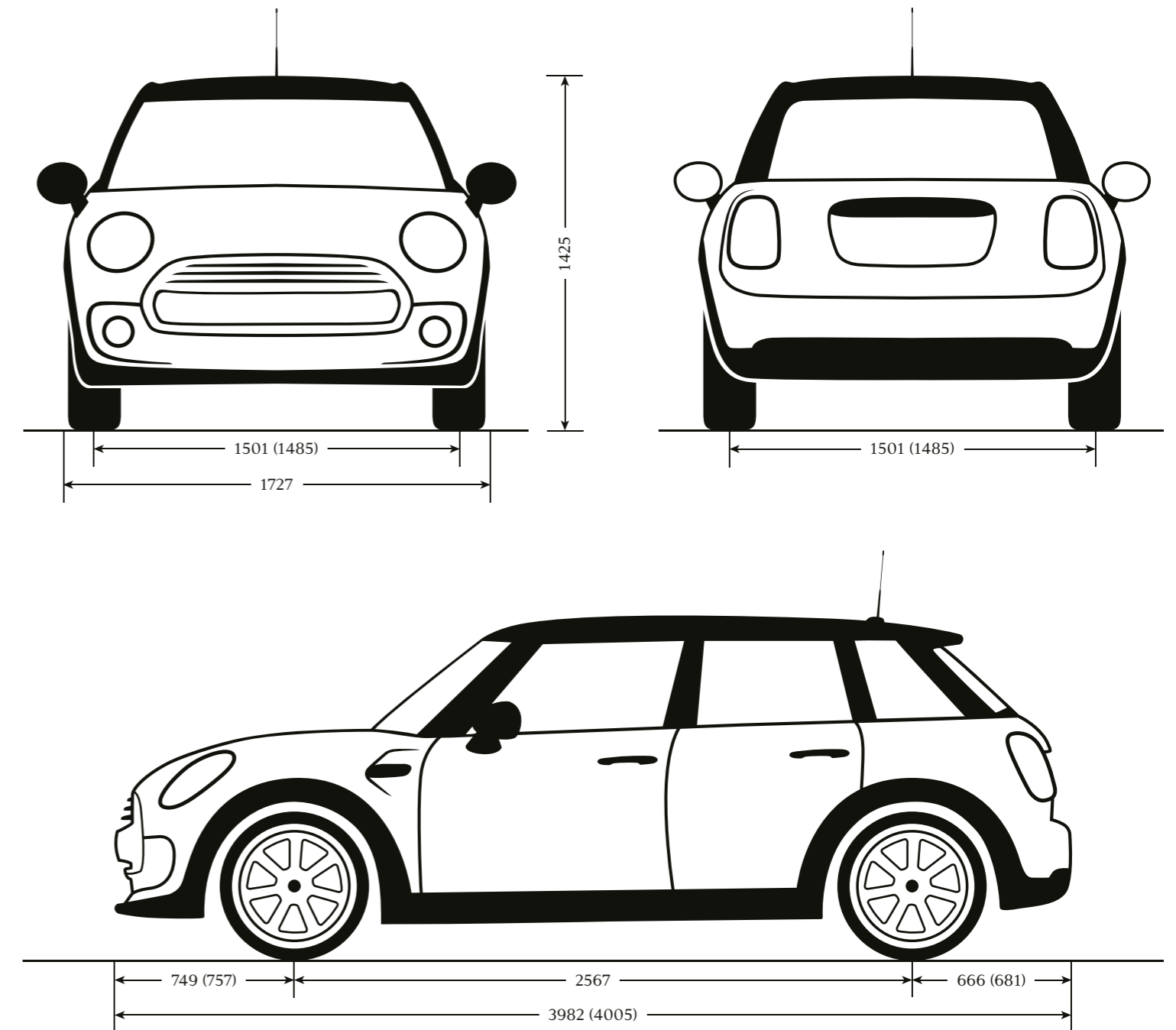

All figures are in millimetres (mm).  
Cooper S values in brackets.



## READY TO EXPLORE MORE CORNERS?

Now you've read about what sets a MINI apart – what it means to drive a MINI is something you have to experience for yourself. Your MINI dealer will be glad to give you the opportunity. Arrange a test drive, slip into the driver's seat, buckle up and press the start button. Open the throttle and enjoy the experience of agile handling and the unique go-kart feeling that made MINI famous. Have a very special day and enjoy your drive.

[mini.com](http://mini.com)



The models, standard and optional equipment and combinability of options in this catalogue relate to cars supplied by BMW AG for the German market. The availability of standard and optional equipment, and configurations of options, may vary for all models in this catalogue after going to press (on 20 December 2018) and may vary from country to country within the European Union. For detailed information about the situation in your country, please contact your authorized MINI dealer. Subject to changes in design and equipment.

© BMW AG, Munich, Germany. Not to be reproduced, wholly or in part, without the written permission of BMW AG, Munich.

For more information, visit:  
[mini.com](http://mini.com)



[facebook.com/mini](https://facebook.com/mini)

MINI ORIGINAL ACCESSORIES  
[mini.com/accessories](http://mini.com/accessories)

MINI COLLECTION  
[shop.mini.com](http://shop.mini.com)

March 2019

