



MINI Wallbox Plus

Instructions for use



MINI Wallbox Plus
Instructions for use

5

EN

MINI Wallbox Plus

Instructions for use

Contents

INFORMATION	9
Safety information	9
Intended use	10
About this manual	11
Warranty	11
OPERATION	12
Displays and controls	12
Start the charging cycle	13
End the charging cycle	13
Status LED information	13
BMW iV app	14
Perform restart	15
AUTHORISATION	16
RFID cards	16
RFID authorisation	16
Configure the authorisation function	17
CONFIGURATION	20
Web interface	20
FAULTS	22
Troubleshooting	22
Possible causes of faults	24
MAINTENANCE	27
Cleaning	27
Maintenance and repair work	27
WASTE DISPOSAL	28
SOFTWARE UPDATE	29
PRODUCT INFORMATION PAGE	30

HOUSING	31
Remove the housing cover	31
Remove the terminal panel cover	32
Installing the terminal panel cover	33
Install the housing cover	34
INDEX	35

Legal notice

Bayerische Motorenwerke Aktiengesellschaft

Munich, Germany

www.bmw.com

Original operating instructions

Copyright ©2019 BMW AG Munich

This documentation contains information protected by copyright. All rights reserved, especially the rights of reproduction and distribution. No part of this documentation may be reproduced (photocopying, scanning or any other procedures) or processed, copied or distributed in any form using electronic systems without the written consent of Bayerische Motorenwerke Aktiengesellschaft.

Contraventions are liable to compensation.

About this manual

We are delighted that you have decided to buy a MINI Wallbox.

Read the manual for this device carefully before you charge your vehicle. Keep this document to hand at all times near the Wallbox since it contains important information for charging the high voltage batteries found in electric or plug-in hybrid vehicles.

Use the installation manual to install the Wallbox and to store and transport it. The manual contains all the technical data and details of the ambient conditions.

Have fun and enjoy your BMW Wallbox.

BMW AG

Symbols used

You will find information and warnings about possible dangers at various points in the manual. The symbols used in the manual have the following meanings:



WARNING

Means that death or serious physical injury may occur if the appropriate precautions are not taken. ◀



CAUTION

Means that property damage or minor physical injury may occur if the appropriate precautions are not taken. ◀



IMPORTANT

Means that property damage may occur if the appropriate precautions are not taken. ◀



ESD

This warning points out the possible consequences of touching electrostatically sensitive components. ◀



Note

Indicates procedures which do not involve any risk of injury. ◀



This lightning symbol means a danger of electric shock.

Access for trained, authorised electricians only.

INFORMATION

Safety information



WARNING

- ▷ Electrical danger!
The Wallbox must be installed, commissioned and serviced by appropriately trained, qualified and authorised electricians⁽¹⁾ who bear full responsibility for compliance with current standards and installation regulations. See the installation manual for details.
- ▷ Electrical danger/fire hazard!
Never use defective, worn or dirty charging cable plugs.
- ▷ Electrical danger!
If the status LED is permanently lit in red, the Wallbox must be disconnected from the supply until the device has been replaced. The voltage on the charging cable cannot be switched off.
- ▷ The owner (end customer) must ensure that the Wallbox is operated only if it is in perfect condition.
- ▷ The Wallbox must be checked at regular intervals for defects on the socket or charging cable plug (including charging cable) and for signs of damage to the housing (visual inspection).
- ▷ Repair work to the Wallbox is not permitted, and may be completed only by the manufacturer or a trained expert (Wallbox replacement).
- ▷ A damaged Wallbox must be switched off and replaced without delay.
- ▷ Do not make any unauthorised changes or modifications to the Wallbox.
- ▷ Do not remove any identifiers such as safety symbols, warning instructions, rating plates, labels or cable markings.
- ▷ The Wallbox does not have a main switch. The device plug and circuit breaker for the building installation can be used to disconnect the supply circuit.
- ▷ Do not use an extension cable for connecting an electric or plug-in hybrid vehicle to the Wallbox.
- ▷ Connect only electric or plug-in hybrid vehicles or their chargers. Do not connect any other loads (electric tools, etc.).
- ▷ Pull the charging cable out of the connector by the plug, not the cable.
- ▷ Ensure that the charging cable is not mechanically damaged (kinked, jammed, or run over) and that the contact area does not come into contact with heat sources, dirt or water.
- ▷ Always conduct a visual inspection for signs of damage before charging. Pay particular attention to dirt and moisture on the charging plug, cuts on the charging cable or chafing on the insulation, and also ensure that the cable output from the Wallbox is securely fastened. ◀

⁽¹⁾ People who, as a result of their specialist training, skills and experience and knowledge of the relevant standards can assess the work and identify possible dangers.



CAUTION

- ▷ Ensure that the Wallbox is not damaged by incorrect handling (housing cover, internal parts, etc.).
- ▷ Pull the charging cable out of the connector using only the charging cable plug, not the cable.
- ▷ Ensure that the charging cable is not mechanically damaged (kinked, jammed, or run over) and that the contact area does not come into contact with heat sources, dirt, or water. ◀



IMPORTANT

- ▷ If it is raining or snowing and the Wallbox is installed outdoors, do not open the terminal panel cover.
- ▷ Wait until a current charging cycle has been finished and the vehicle has been disconnected before you open the covers. ◀

Intended use

The Wallbox is a charging station for indoor and outdoor use, designed to charge electric or plug-in hybrid vehicles. Do not connect any other devices such as electric tools. The Wallbox is designed for installation on a wall or a column. Comply with the relevant national regulations for installing and connecting the Wallbox.

The intended use of the device in every case includes compliance with the ambient conditions for which this device was developed.

The Wallbox was developed, manufactured, tested and documented on the basis of the relevant safety standards. If you comply with the instructions and safety information described for its intended use, the product will therefore not normally pose any danger in terms of property damage or to the health of people.

This device must be earthed. In the event of an error, the earth connection will reduce the danger of an electric shock.

The instructions contained in this manual must in any event be followed exactly. Otherwise, sources of danger may be created or safety equipment may be rendered ineffective. In addition to the safety information provided in this manual, the safety and accident prevention regulations relating to the specific device must be followed.

As a result of technical or statutory restrictions, not all versions/options are available in all countries.

About this manual

This manual and the functions described in it are valid for devices of the following type:

- ▷ MINI Wallbox Plus

The illustrations and explanations contained in this manual refer to a typical version of the device. Your device version may differ from this.

This manual is aimed at the following target groups:

- ▷ End customers (users of the Wallbox)
- ▷ Commissioning technicians, service technicians

Warranty

MINI Service can provide more information on the terms of the warranty. However, the following cases are not covered by the warranty.

- ▷ Defects or damage caused by installation work which was not carried out as specified in the MINI Wallbox Plus installation instructions.
- ▷ Defects or damaged cause by the product not being used as specified in the MINI Wallbox Plus operating instructions.
- ▷ Costs and damage caused by repair work not carried out by a specialist electrician authorised by a MINI sales outlet or authorised service workshop.

OPERATION

Displays and controls

Version with charging socket

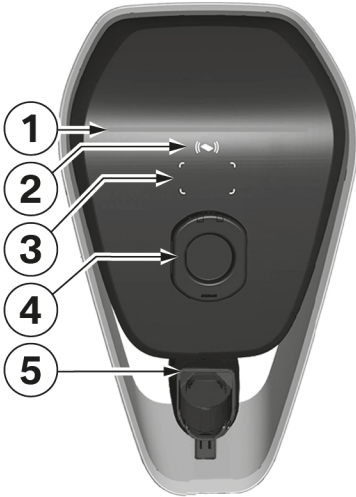

The Wallbox is fitted with a charging socket including shutter (additional contact protection).

Functions:

- ▷ Charging electric or plug-in hybrid vehicles
- ▷ Network connection using LAN
- ▷ Local smartphone app
- ▷ RFID functionality
- ▷ Domestic connection monitoring (post-meter fuse) using a directly connected Modbus RTU (RS485) electricity meter

1 Status LED

2 RFID status indicator

3 RFID reading area

4 Charging socket with shutter





5 Charging cable plug holder



Note

No charging cable is included; a separate charging cable is required. ◀

Start the charging cycle

	<p>RFID authorisation required: If your Wallbox has active RFID functionality, please refer to the instructions in the section entitled RFID authorisation.</p>
	<p>The status LED is permanently lit in blue when the device is not in use and after successful authorisation. Connect the vehicle to the Wallbox if it is not already connected.</p>
	<p>While it attempts to mechanically lock the charging cable plug (version with a charging socket) and perform internal self-tests, the status LED will be lit for several seconds in orange.</p>
	<p>After the self-test has been completed successfully, the status LED will be lit again in blue. The vehicle has been successfully connected and authorised. The charging cycle can then be started from the vehicle.</p>
	<p>The status LED will flash in blue whilst the charging cycle is active. The charging cycle is started by the vehicle and the start can also be delayed depending on the setting in the vehicle.</p>

End the charging cycle

The charging cycle is ended by releasing the vehicle and disconnecting the charging cable. Details of this are described in the manual provided by the vehicle manufacturer. The charging cycle can also be ended by logging off using the RFID card used for the authorisation process.

1. Disconnect the charging cable from the vehicle.

Status LED information







Status LED segments

The status LED provides information on the current state of the Wallbox. It consists of 4 segments, S1 to S4, which may be lit or flash in various colours together or individually.

The status LED will only be visible when the power supply is active and will be hidden when the Wallbox has not been authorised.

Unless otherwise stated, all 4 segments will be lit together.

	<p>Limited charging current due to domestic connection monitoring</p> <p>If the "domestic connection monitoring" function is used, segments S1 and S2 of the status LED will flash in orange if the connection to the energy meter is lost. The charging current will be reduced to 10 A until the connection to the energy meter is restored.</p>
	<p>Temperature cut-out</p> <p>If the maximum temperature limit of the Wallbox is exceeded, the charging cycle will be temporarily stopped, and segments S3 and S4 of the status LED will flash in orange. After the cooling phase the charging process will restart automatically.</p>
	<p>Commissioning mode</p> <p>When commissioning mode is active, segments S2 and S3 of the status LED will be lit in orange.</p>
	<p>Faults</p> <p>If faults occur, they will be indicated by the status LED and special colour codes. For further details, see section Troubleshooting.</p>

BMW iV app

The MINI Wallbox can be controlled via the BMW iV App after the integration into a network. This function is available only within the local network; control over the internet is not possible.

Among other things, the BMW iV App can be used to start or stop charging processes. It is also possible to vary the current of a running charging process.

The latest features and descriptions can be found in the respective app stores. The BMW iV App has been developed for iOS and Android operating systems and is available in the iTunes Store and Google Play Store.

Additional or updated information about the BMW iV App is available on the BMW i Service page for charging products at <https://charging.bmwgroup.com/web/wbdoc/bmw-iv-app>.

Perform restart

Service button



Notes on opening the cover:

Danger of damage. Electronic components may be destroyed if touched.

Before handling modules, perform an electrical discharge process by touching a metallic earthed object.

Wait until a current charging cycle has been finished and the vehicle has been disconnected before you open the covers. ◀

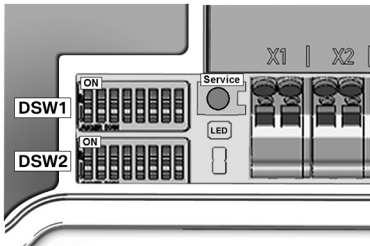

1. Remove the housing cover, see section [Remove the housing cover](#).
2. Remove the terminal panel cover, see section [Remove the terminal panel cover](#), to gain access to the **service button**.
3. When the work is complete, install the terminal panel cover and the housing cover. To do this, follow the instructions in sections [Installing the terminal panel cover](#) and [Install the housing cover](#).



1. Press the **service button** until the **1st signal tone** sounds (about two seconds). The device will then perform a restart.



IMPORTANT

If the **Service button** is pressed for too long (around 5 seconds), the RFID cards may be deleted. ◀

AUTHORISATION



The authorisation function is enabled when the system is delivered. The RFID cards supplied are programmed at the factory. ◀

RFID cards

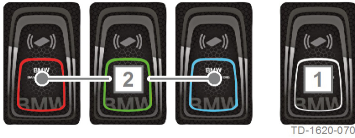

The four supplied RFID cards are used to authorise the users at the Wallbox.



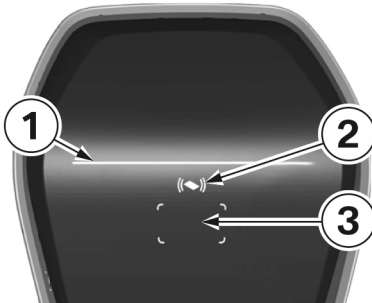

- 1** RFID master card (white)
- 2** RFID user card (red, green, blue)

RFID authorisation



The RFID sensor is designed to provide contactless authorisation of a user for charging at the Wallbox using **RFID cards** which comply with ISO14443 and ISO15693.

- 1** Status LED
- 2** RFID status indicator
- 3** RFID reading area

	<p>Authorisation required The RFID status indicator 2 and the border of the RFID reading area 3 flash in white.</p>
	<p>1. Hold the RFID card in front of the RFID reading area 3.</p>
	<p>Authorisation successful Successful authorisation is indicated by a rising sequence of tones, and the RFID status indicator 2 will be lit for 2 seconds in green.</p>
	<p>Authorisation failed Failed authorisation is indicated by a falling sequence of tones, and the RFID status indicator 2 will be lit for 2 seconds in red.</p>
	<p>Charging process enabled If the charging cycle is not started within 60 seconds of a successful authorisation, the system enable will be automatically cancelled. During the enable time, the status LED 1 will be lit in blue. During this time it is not possible to enable or disable the system using a different card.</p> <p>1. Now connect the vehicle. The charging process can then be started from the vehicle.</p>

Configure the authorisation function



Note

The authorisation function of the Wallbox can be disabled. To disable the authorisation function and delete the user cards, it is necessary to remove the housing cover and the terminal panel cover from the Wallbox to gain access to the **service button**. ◀



Note

There must be no electric vehicle connected during the configuration of the authorisation function. ◀

Service button



Notes on opening the cover:

Danger of damage. Electronic components may be destroyed if touched.

Before handling modules, perform an electrical discharge process by touching a metallic earthed object.

Wait until a current charging cycle has been finished and the vehicle has been disconnected before you open the covers. ◀

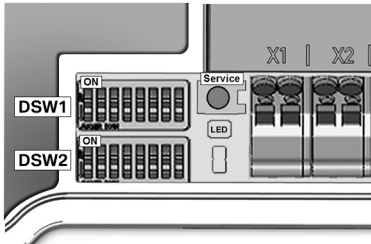

1. Remove the housing cover, see section [Remove the housing cover](#).
2. Remove the terminal panel cover, see section [Remove the terminal panel cover](#), to gain access to the **service button**.
3. When the work is complete, install the terminal panel cover and the housing cover. To do this, follow the instructions in sections [Installing the terminal panel cover](#) and [Install the housing cover](#).

Program the RFID master card

	<ol style="list-style-type: none">1. Press the service button until the 2nd signal tone sounds (around 6 seconds). All the saved RFID cards (including the master card) will now be deleted and an automatic restart will be performed.
	<ol style="list-style-type: none">2. After the restart, as soon as the RFID reading area is displayed, hold the RFID master card in front of the RFID reading area within 60 seconds and wait for the signal tone. The RFID master card is now programmed. Keep it in a safe place. The RFID master card can also be used to authorise a charging cycle.

Program an additional RFID user card





Note

The following process is not possible when a vehicle is connected. ◀



Note

A total of 20 cards can be programmed on the Wallbox. ◀

 	<ol style="list-style-type: none">1. End a current charging cycle and disconnect the vehicle from the Wallbox.2. Hold the RFID master card in front of the RFID reading area and wait for the signal tone.3. Within 5 seconds hold the new RFID user card in front of the RFID reading area and wait for the signal tone. The RFID status indicator will change to orange.4. Within 5 seconds hold the RFID master card in front of the RFID reading area again and wait for the signal tone as confirmation. The RFID user card is now programmed and the RFID status indicator will change back to white.
--	--

Delete all RFID cards in the memory

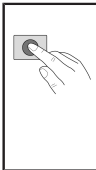

1. Press the **service button** until the **2nd signal tone** sounds (around 6 seconds). All the saved RFID cards (including the master card) will now be deleted and an automatic restart will be performed.
2. Now restart the programming process for the RFID master card if you wish to retain the RFID function.

Disable the RFID function

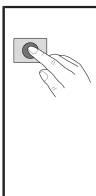

1. Press the **service button** until the **2nd signal tone**. All the saved RFID cards (including the master card) will now be deleted and an automatic restart will be performed.
2. The RFID function will be disabled if no RFID card is held in front of the reading zone for the next **60 seconds**. After it has been disabled, the RFID status indicator will go out.

CONFIGURATION

Wallbox Configuration Information	
Ethernet MAC:	00:60:B5:01:02:03
RFID-1 W:01020304	RFID-2 R:01020304
RFID-3 G:01020304	RFID-4 B:01020304
DE: Achtung: Bitte gut aufbewahren	NL: Opgelet: s.v.p. goed bewaren
IT: Attenzione: conservare con cura	NO: Oppbevar på et trygt sted
SV: Obs! Förvaras på ett säkert ställe	
EN: Important: Please keep in a safe place	
FR: Attention: prière de bien conserver	
PT: Atenção: por favor, guardar em local seguro	
RU: Внимание: храните в безопасном месте	

This configuration label is supplied in a bag together with the RFID cards.



Note

Keep this label safe. ◀

Web interface

The Wallbox has an integral web server, and can display a wide range of information (status information, measurements, log information). It is not possible to change the settings here.



Note

The web interface can be used to find whether the values of the meter installed for domestic connection monitoring can be read correctly. ◀



Note

The IP address of the Wallbox has been configured as described in the installation instructions, and must be identified in the "DHCP" setting, for example using the router on your network. ◀

Opening the web interface

1. Enter the IP address or the DNS name of the Wallbox assigned by your router into the address line of your internet browser. Example: **http://192.168.0.10**

Wallbox



- [Status](#)
- [Log](#)

Status

Product-ID	BMW-10-ESS40022-E1R-SN-16914905-ML-17025970
MAC Address	00.60.b5.35.61.06
Software	P30 v 3.04.3b4 (160929-121550) : 29889 : 311.0 : 2020004
Service Info	0 : 0 0 : 0 : 0 : 20 : 271 47 : 95 : 77
State / Seconds	disabled : seconds : 10117
Current limit (PWM hardware setup)	0,00A (100,0% duty cycle 20A)

Energy Monitor

Voltage	0 0 0 V
Current	0,00 0,00 0,00 A
RealPower PowerFactor	0,00 kW 0,0 %
Energy (present session)	0,08 kWh
Energy (total)	0,29 kWh
Energy (housegrid meter) in out	2435,2 kWh 0kWh
Energy (solar meter) in out	3576,4 kWh 47869,1 kWh

* Voltage and current show present values for L1 | L2 | L3
* Values displayed may not be used for billing purposes
* Energy monitor values shown as --- indicate, not available with this product

<http://www.becontact.com/>

Copyright © 2015

FAULTS



Note

Additional or updated information such as operating and installation instructions are available on the service page at <https://charging.bmwgroup.com/web/wbdoc/>. ◀



Note

If the displayed error code is not listed here, please contact MINI Service. ◀

Troubleshooting

PROBLEM	Possible cause
Status LED not lit	<ol style="list-style-type: none">1. No voltage supply – check the residual-current circuit breaker and power circuit breaker, and switch on if necessary.2. Fault on the Wallbox – contact your service partner if necessary.
Charging cycle not started	<ol style="list-style-type: none">1. The charging cable plug has not been inserted correctly – remove the charging cable plug and reconnect it.2. The vehicle does not require any energy or has a fault – check the vehicle.3. Authorisation not completed correctly – follow the instructions in the manual.4. The vehicle has been programmed for a later starting time for the charging cycle.
Vehicle not fully charged / extended charging time	<ol style="list-style-type: none">1. Local domestic connection monitoring of the Wallbox is active due to increased domestic current consumption.2. No enable, delayed charging start, or limited charging current due to iV app.3. No enable or limited charging current, due to SmartHome domestic controller.

<p>Vehicle not fully charged / extended charging time</p>	<ol style="list-style-type: none"> 4. Vehicle settings incorrect, for example charging mode or departure time. 5. Power reduction due to high temperature on the vehicle or Wallbox – protect the vehicle and Wallbox from direct sunlight during the charging cycle (carport, garage). Conduct a visual inspection of the plug connector for dirt, wear, or damage. Contact your service partner if necessary.
<p>Charging cable plug cannot be disconnected</p>	<ol style="list-style-type: none"> 1. The charging cycle has not been ended by the vehicle – end the charging cycle as described in the manual provided by the vehicle manufacturer. 2. The charging cable plug may not be released when pulled – push in the charging cable plug and release it again on the vehicle.
<p>Status LED flashes in red (all parts of the status LED flash in red combined with white or blue)</p>	<ol style="list-style-type: none"> 1. Fault – first check the possible causes of the fault, see section entitled Possible causes of faults. Switch off the supply voltage to the Wallbox using the appropriate mains cut-off device. Disconnect the charging cable and switch on the supply voltage again.
<p>Status LED permanently lit in red</p>	<ol style="list-style-type: none"> 1. The Wallbox cannot shut down the voltage on the charging cable – restart the Wallbox. If the problem persists, disconnect the Wallbox from the mains and replace it. 2. The protective conductor is not connected – connect the protective conductor correctly. 3. The protective conductor connection has too high a resistance – connect the protective conductor correctly. 4. The CCID test was not successful. If the problem persists, replace the Wallbox.





Reset an error

If an interruption occurs during a connection or charging cycle, the Wallbox will attempt to restart the cycle automatically (a maximum of five times).

If the charging cycle cannot be restarted, this must be acknowledged by correctly ending the charging cycle or, if necessary, by restarting the Wallbox. If an error occurs repeatedly or for no obvious reason, contact your service partner.

Possible causes of faults

General errors (displayed in red and white)

 <p>"white/white/white/red"</p>	<p>Error 1 [0001]</p> <ol style="list-style-type: none">1. The vehicle was disconnected again during the Wallbox self-tests (status LED lit in orange).2. The charging cable plug was disconnected during the charging process: The charging cable plug was not correctly locked – disconnect the charging cable plug and reconnect correctly, ensuring that it locks properly.
 <p>"white/white/red/white"</p>	<p>Error 2 [0010], version with charging socket only</p> <p>MINI fast charging cable not recognised: Disconnect and reconnect the fast charging cable; have it checked at the workshop if necessary.</p>
 <p>"white/white/orange/orange"</p>	<p>Error 3 [0011]</p> <p>Temperature cut-out: The maximum temperature in the Wallbox was exceeded. After briefly displaying the error code, status LED segments S2 and S4 will flash in orange until the Wallbox has cooled down.</p>
 <p>"white/red/white/white"</p>	<p>Error 4 [0100], version with charging socket only</p> <p>The charging cable plug could not be locked: Disconnect the charging cable plug and reconnect it quickly, have it checked at the workshop if necessary.</p>

 <p>"white/red/white/red"</p>	<p>Error 5 [0101]</p> <p>The Wallbox has not detected an electric or plug-in hybrid vehicle, but instead an unauthorised load: Only electric vehicles which comply with the standard may be charged. Remove the unauthorised load and restart the charging process.</p>
---	--

 <p>"red/white/white/white"</p>	<p>Error 8 [1000]</p> <p>The charging cable plug on the Wallbox is emitting an invalid state: Cable hardware error – disconnect the charging cable plug and reconnect properly, if necessary replace the cable.</p>
---	--

Errors on the power unit (displayed in red and blue)

 <p>"blue/blue/blue/red"</p>	<p>Error 8001 [0001]</p> <p>The charging voltage cannot be switched on; internal error or hardware defective: Reconnect the vehicle or restart the Wallbox. If the error occurs again, contact your service outlet.</p>
--	--

 <p>"blue/blue/red/blue"</p>	<p>Error 8002 [0010]</p> <p>Input voltage outside permitted range. Cross-section too low or cable too long: Reduce the preset current, or have the supply cable upgraded by an electrician. Voltage limits (min.-max.): 160 V – 280 V If necessary, ask your energy supplier about the maximum voltage tolerances in the mains.</p>
--	--

	Error 4003 [0011]
"blue/blue/red/red"	<p>Overcurrent detected in the vehicle: The vehicle has not complied with the permitted maximum current and was shut down – if the problem continues, have the vehicle inspected in a workshop.</p>

	Error 8005 [0101]
"blue/blue/blue/red"	<p>Residual current monitor: An error was identified during the self-test or the monitor has tripped as a result of an excessive fault current. Check your charging cable for signs of damage or water accumulation in the plug. The monitor may also trip due to a lightning strike in the surrounding area.</p>

	Error 8007 [0111]
"blue/red/red/red"	<p>Safety monitor: A problem relating to the internal safety circuit has been identified. It is possible that the contacts on the charging contactor can no longer be opened. In this state the Wallbox cannot perform an automatic restart attempt. The Wallbox must be restarted at the mains. In certain cases the error may relate to a problem in this software. A software update may rectify the error, see section SOFTWARE UPDATE. If the device continues to display the error after the software has been updated, please contact your service partner.</p>

MAINTENANCE

Cleaning



IMPORTANT

Danger of damage.

Avoid possible damage through the following:

- ▷ Aggressive solvents and cleaning products
- ▷ Scouring materials
- ▷ Cleaning with water jets, for example a pressure cleaner
- ▷ Excessive pressure

Comply with the instructions on the cleaning product. ◀

Clean the housing of the Wallbox Pure using a damp cloth as required. Stubborn dirt can be removed using a mild, solvent-free, non-scouring cleaning product.



Note

We recommend using cleaning and care products which have been tested by BMW:

Special matt paint cleaner for the housing, number 83 12 2 285 244.

Glass cleaner for high gloss surfaces, number 83 12 2 288 901. ◀

Maintenance and repair work



If you have any questions or problems, please contact your electrical installation contractor. Repair work may only be carried out by trained personnel. Before you contact your service partner:

1. Check the troubleshooting guide in this manual and in the manual supplied with your vehicle.
2. Make a note of the model version and serial number. The model plate **1** is on the right-hand side of the Wallbox.

WASTE DISPOSAL



After proper decommissioning of the device, please have the device disposed of by service or dispose of it in compliance with all currently valid disposal regulations.



Waste disposal information

The symbol of the crossed out really been means that electrical and electronic devices and the accessories must be disposed of separately from general household waste. Information is provided on the product, in the instructions for use or on the packaging.

The materials can be recycled on the basis of their identifying marks. You can make a valuable contribution to protecting our environment by reusing them, recycling the material or other forms of reuse of end of life devices.

SOFTWARE UPDATE

The software for the Wallbox can also be updated using the USB connector inside the device. The housing cover and the terminal panel cover must be removed to gain access to the USB connector.

Follow the instructions in the manual for performing software updates.



The latest **software** and associated instructions can be downloaded from the internet at <https://charging.bmwgroup.com/web/wbdoc/>. A new software version may, for example, take account of changed standards or improve compatibility with new electric or plug-in hybrid vehicles.

PRODUCT INFORMATION PAGE



This telecommunications equipment complies with the NTC requirement.

HOUSING



Note

This section is relevant only if explicit reference is made to it in this manual. ◀

Remove the housing cover

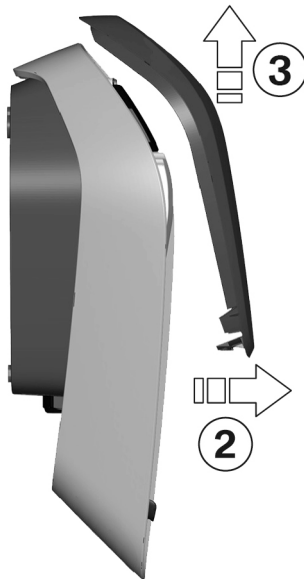
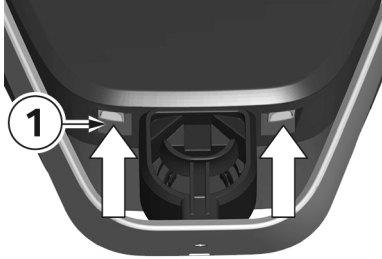

1. Press the two locks **1** for the housing cover on the underside of the Wallbox upwards. The housing cover should then jump out slightly at the bottom.

2. Swing the housing cover forwards a little on the underside **2**.
3. Then release the housing cover by raising it **3**.



Note

Keep the housing cover in the packaging to prevent it being scratched or suffering other damage. ◀

Remove the terminal panel cover



ESD

Danger of damage. Electronic components may be destroyed if touched.

Before handling modules, perform an electrical discharge process by touching a metallic earthed object. ◀

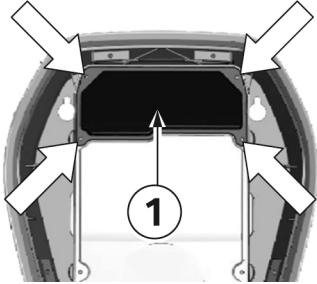

1. Undo the four screws used to secure the terminal panel cover **1**.



WARNING

Electrical danger.

The terminal cover **3** next to the terminal panel **2** may be removed only by appropriately trained, qualified and authorised electricians. ◀

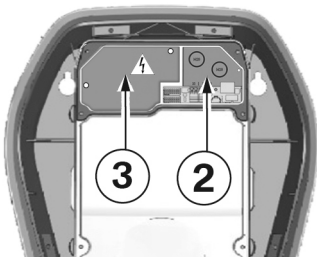

2. Remove the terminal panel cover. The terminal panel **2** is now accessible.

Installing the terminal panel cover



Note

Confirm that an up-to-date version of the software is available before you install the terminal panel cover. For further information see section [SOFTWARE UPDATE](#). ◀



Note

The Wallbox must not be permanently commissioned if this cover is missing or damaged. Alternative covers must not be used. ◀

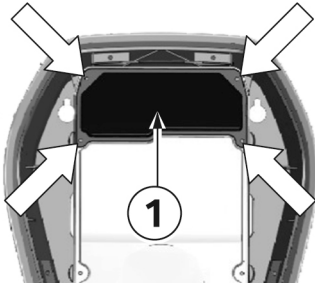

Fastening screws

1. Insert the terminal panel cover **1** again.
2. Install the terminal panel cover again using the four screws.

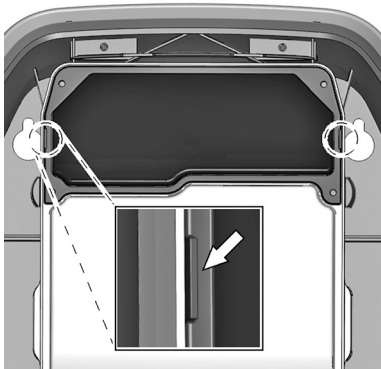

Housing marking

1. Tighten the four screws until the housing markings on the right and left of the terminal panel cover are flush with the housing.
2. The terminal panel cover must correctly seal the housing.

Increased force is required for the self-tapping screws: 3.5 Nm.

Install the housing cover



Note

This cover is not relevant for the safe operation of the Wallbox. ◀

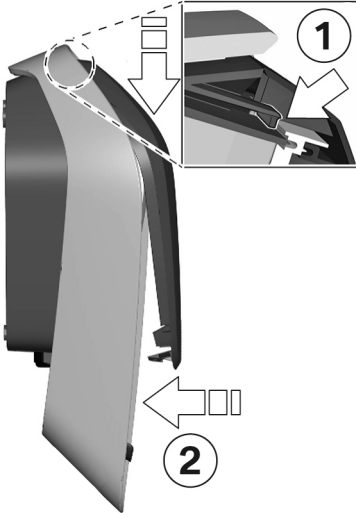

Attaching the housing cover

1. Attach the housing cover at the top, and ensure that the hooks on the housing cover are correctly attached **1**.
2. Press the cover downwards and then swing the housing cover **2** backwards.
The housing cover must slide into the bottom guides without any major resistance.



IMPORTANT

Ensure that the housing cover is correctly positioned in the housing guide on all sides. There must be only a uniform minimum gap. ◀

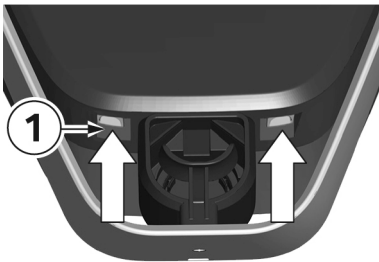

Locks

1. Press the bottom section of the housing cover on to the Wallbox until the locks **1** fully engage.

INDEX

A

About this manual.....	11
Authorisation.....	16

C

Cleaning.....	27
Commissioning mode.....	14

D

Delete RFID cards.....	19
Disable the RFID function.....	19
Disposal.....	28

E

End the charging cycle.....	13
Energy meter.....	14

F

Faults.....	22
-------------	----

I

Installing the terminal panel cover.....	33
Install the housing cover.....	34
Intended use.....	10

M

Maintenance.....	27
MINI Wallbox Plus overview.....	12
Model plate.....	27

O

Opening the web interface.....	21
--------------------------------	----

P

Program an additional RFID user card.....	19
Program the RFID master card.....	18

R

Remove the housing cover.....	31
Remove the terminal panel cover.....	32
Repair.....	27
RFID.....	16
RFID cards.....	16

S

Safety instructions..... 9
Service button..... 15, 18
Start the charging cycle..... 13
Status LED..... 13

T

Temperature cut-out..... 14

W

Web server..... 20

EU Declaration of Conformity

We declare that the following product(s)

Name of product	Wallbox Plus 22kW T2
BMW part number	61 90 2420905
Model / Type Ref.	BMW-10-EC240522-E1R
Type of product	Electric vehicle conductive charging system

Name of product	Wallbox Plus 22kW T2S
BMW part number	61 90 2420913
Model / Type Ref.	BMW-10-ESS40022-E1R
Type of product	Electric vehicle conductive charging system

Name of product	Wallbox Plus 22kW T2S
BMW part number	61 90 272423
Model / Type Ref.	MIN-10-ESS40022-E1R
Type of product	Electric vehicle conductive charging system

Name of product	Wallbox Connect 22kW T2
BMW part number	61 90 2420912
Model / Type Ref.	BMW-10-EC2405B2-E1R
Type of product	Electric vehicle conductive charging system

Company
Bayerische
Motoren Werke
Aktiengesellschaft

Issuing department
CP-152
Product Management
Accessories
Electric, consumer
electronics & eMobility

Postal address
BMW AG
80788 München

Office address
Frankfurter Ring 7-9
80807 München

Telephone
Switchboard
+49 89 382-0

Fax
+49 89 382-25858

Internet
www.bmwgroup.com

Bank details
Deutsche Bank
IBAN DE05 7007 0010
0152 6946 00
BIC DEUTDE33

**Chairman of the
Supervisory Board**
Norbert Reithofer

Board of Management
Harald Krüger,
Chairman
Milagros Caiña Carreiro-
Andree
Klaus Fröhlich
Pieter Nota
Nicolas Peter
Ian Peter
Schwarzenbauer
Andreas Wendt
Oliver Zipse

**Registered in
Germany**
München HRB 42243

is/are in conformity with the following European Council Directive(s):

- **EU-Directive 2014/53/EU**
- **EU-Directive 2011/65/EU**

Conformity to the directive 2014/53/EU is assured by the compliance with the applicable parts of the following harmonized European standards:

- **EN 300 330 V2.1.1**
- **EN 300 328 V2.1.1 (1)**

Conformity to the directive 2011/65/EU is assured by the compliance with the applicable parts of the following harmonized European standards:

- **EN 50581:2012**

The conformity to the directive 2014/53/EU is not impaired by the removal or the installation of the BMW communications module (WLAN/WiFi functionality). The BMW communications module itself is also in conformity with 2014/53/EU. Conformity to the essential requirements defined in Art. 3 No. 1 Lit. (b) 2014/53/EU concerning 2014/30/EU is assured by the compliance with the applicable parts of the following harmonized European standards:

- **EN 61000-6-2:2005**
- **EN 61000-6-3:2007 + A1:2011**
- **EN 61000-3-11:2000**
- **EN 61000-3-12:2011**
- **EN 301 489-1 V1.9.2**

Conformity to the essential requirements defined in Art. 3 No. 1 Lit (a) 2014/53/EU concerning 2014/35/EU is assured by the compliance with the applicable parts of the following harmonized European standards:

- **EN 61851-1:2011**
- **EN 61851-22:2002**
- **EN 61439-1:2011**
- **EN 50364:2010**
- **EN 62479:2010 ⁽¹⁾**

The assessment and testing concerning human exposition was performed according to the following requirements:

- **Council Recommendation of 12 July 1999 on the limitation of exposure of the general public to electromagnetic fields (0 Hz to 300 GHz) 1999/519/EC**

The following operating parameters are specified for the RFID module of the device:

- **Frequency: 13,553 – 13,567 MHz**
- **EIRP: 0,200 μ W**

The following operating parameters are specified for the WLAN/WiFi module of the device:

- **Frequency: 2400 – 2483,5 MHz ⁽¹⁾**
- **EIRP: 100 mW ⁽¹⁾**

Important notes:

Any modification on the product(s) that is performed without the consent of BMW will render this declaration invalid. This declaration certifies the conformity with the directives mentioned, but does not imply any warranty of the features of the product(s). The safety instructions contained in the documentation supplied with the product(s) must be followed.

This declaration of conformity is issued under the sole responsibility of the manufacturer.

⁽¹⁾ Only applicable if the BMW communication module is installed.



München, 11.04.2019

Place, Date

Michael Fischmann
CP-152, Product Management Accessories



Doc #108155 - Mat #108155